

Contract Routing Form

ROUTING: Routine

printed on: 05/08/2018

Contract between: Fahrner Asphalt Sealers, LLC
and Dept. or Division: Engineering Division
Name/Phone Number:

Project: Chip Sealing 2018 - East

Contract No.: 8093
Enactment No.: RES-18-00337
Dollar Amount: 1,111,337.16

File No.: 51215
Enactment Date: / /

(Please DATE before routing)

Signatures Required	Date Received	Date Signed
City Clerk	5-8-18	5-8-18
Director of Civil Rights	5.8.18	5.9.18 FNS
Risk Manager	5/11/18	5/11/18 RN
Finance Director	05-11-2018	5/14/18 MCR
City Attorney	529 5-16-18	5-18-18
Mayor	05.18.18	05.18.18
Finance for scanning		5/18/18 MQ

Please return signed Contracts to the City Clerk's Office
Room 103, City-County Building for filing.

Original + 2 Copies

05/04/2018 08:19:56 enjls - Steve Sonntag 267-1197

Dis Rights: OK / ~~OK~~ / Problem - Hold
Prev Wage: AA / Agency / No
Contract Value: 1,111,337.16
AA Plan: Approved
Amendment / Addendum #
Type: POS / Dvlp / Sbdv / Gov't /
Grant / PW / Goal / Loan / Agrmt



Legislation Details (With Text)

File #: 51215 **Version:** 1 **Name:** Awarding Public Works Contract No. 8093, Chip Sealing 2018 - East.

Type: Resolution **Status:** Passed

File created: 4/12/2018 **In control:** BOARD OF PUBLIC WORKS

On agenda: 5/1/2018 **Final action:** 5/1/2018

Enactment date: 5/7/2018 **Enactment #:** RES-18-00337

Title: Awarding Public Works Contract No. 8093, Chip Sealing 2018 - East.

Sponsors: BOARD OF PUBLIC WORKS

Indexes:

Code sections:

Attachments: 1. Contract 8093 .pdf

Date	Ver.	Action By	Action	Result
5/1/2018	1	COMMON COUNCIL	Adopt Under Suspension of Rules 2.04, 2.05, 2.24, and 2.25	Pass
4/18/2018	1	BOARD OF PUBLIC WORKS	RECOMMEND TO COUNCIL TO ADOPT UNDER SUSPENSION OF RULES 2.04, 2.05, 2.24, & 2.25 - REPORT OF OFFICER	Pass
4/12/2018	1	Engineering Division	Refer	

The proposed resolution awards the contract for the chip sealing improvements in 2018 for aldermanic districts 15, 17, and 18. The repairs will be made at a total estimated cost of \$1.14 million. Funding is provided by the Engineering Major Streets capital program Pavement Management (MUNIS 11784); \$15.5 million is budgeted in this program for 2018. The Streets Division has budgeted \$70,000 within their supplies budget for the work they will perform to patch these streets.

Awarding Public Works Contract No. 8093, Chip Sealing 2018 - East.
 BE IT RESOLVED, that the following low bids for miscellaneous improvements be accepted and that the Mayor and City Clerk be and are hereby authorized and directed to enter into a contract with the low bidders contained herein, subject to the Contractor's compliance with Section 39.02 of the Madison General Ordinances concerning compliance with the Affirmative Action provisions **and subject to the Contractor's compliance with Section 33.07 of the Madison General Ordinances regarding Best Value Contracting:**

BE IT FURTHER RESOLVED, that the funds be encumbered to cover the cost of the projects contained herein.

See attached document (Contract No. 8093) for itemization of bids.

SPD

PROJECT _____ CONTRACTOR _____ AMOUNT OF BID _____

CONTRACT NO. 8093
CHIP SEALING 2018 – EAST

FAHRNER ASPHALT SEALERS, L.L.C.

\$1,111,337.16

Acct. No. 11784-402-200: 54410 (91384)	\$1,035,811.16
Contingency 3%±	<u>31,078.84</u>
Sub-Total	\$1,066,890.00

Acct. No. 44552-54250-00000 (91384)	\$75,526.00
Contingency 3%±	<u>2,264.00</u>
Sub-Total	\$77,790.00

GRAND TOTAL	<u>\$1,144,680.00</u>
-------------	-----------------------

Jurisdiction: Wisconsin

Demographics

Company Name: Western Surety Company
Short Name:
SBS Company Number: 54219777
NAIC CoCode: 13188
FEIN: 46-0204900
Domicile Type: Foreign
State of Domicile: South Dakota
Country of Domicile: United States
NAIC Group Number: 218 - CNA INS GRP
Organization Type: Stock
Date of Incorporation: 07/10/1900
Merger Flag: No

Address

Business Address

Not Available
 Not Available, UN 99999
 United States

Mailing Address

333 S WABASH AVE
 CHICAGO, IL 60604
 United States

Statutory Home Office Address

101 S Reid Ave
 Sioux Falls, SD 57103
 United States

Main Administrative Office Address

101 S Reid Ave
 Sioux Falls, SD 57103
 United States

Phone, E-mail, Website

Phone

Type	Number
Mailing Primary Phone	(312) 822-5000
Mailing Fax Phone	(312) 260-4376
Statutory Home Office Primary Phone	(312) 822-5000
Main Admin Office Primary Phone	(312) 822-5000

Email

No results found.

Website

No results found.

Company Type

Company Type: Property and Casualty
Status: Active
Status Reason:
Status Date: 05/29/1942
Effective Date: 05/29/1942
Legacy State ID: 111843
Issue Date: 05/29/1942
Approval Date:
File Date:
Articles of Incorporation Received: No
Article No:
COA Number:

Appointments

Licensee Name	License Number	NPN	License Type	Line of Authority	Appointment Date	Effective Date	Expiration Date
NICOLE LANGER	8856714	8856714	Intermediary (Agent) Individual	Casualty	07/29/2010	03/01/2018	03/15/2019

First	Previous	1	Next	Last
-------	----------	---	------	------

Line Of Business

Line of Business	Citation Type	Effective Date
Fidelity Insurance	Fidelity Insurance	05/29/1942
Surety Insurance	Surety Insurance	05/29/1942
Liability and Incidental Medical Expense Insurance (other than automobile)	Liability and Incidental Medical Expense Insurance (other than automobile)	05/29/1942

First	Previous	1	Next	Last
-------	----------	---	------	------

Contact

Contact Type	Preferred Name	Name	E-mail	Phone	Address
--------------	----------------	------	--------	-------	---------

© 2018 National Association of Insurance Commissioners. All rights reserved.

Company Merger

No results found.

Name Change History

No results found.

\$1,111,337.16
ORIGINAL

BID OF FAHRNER ASPHALT SEALERS, L.L.C.

2018

PROPOSAL, CONTRACT, BOND AND SPECIFICATIONS

FOR

CHIP SEALING 2018 - EAST

CONTRACT NO. 8093

PROJECT NO. 11784

IN

MADISON, DANE COUNTY, WISCONSIN

AWARDED BY THE COMMON COUNCIL
MADISON, WISCONSIN ON MAY 1, 2018

CITY ENGINEERING DIVISION
1600 EMIL STREET
MADISON, WISCONSIN 53713

<https://bidexpress.com/login>

**CHIP SEALING 2018 - EAST
CONTRACT NO. 8093**

INDEX

SECTION A: ADVERTISEMENT FOR BIDS AND INSTRUCTIONS TO BIDDERSA-1
SECTION B: PROPOSAL SECTION B-1
SECTION C: SMALL BUSINESS ENTERPRISE C-1
SECTION D: SPECIAL PROVISIONS D-1
SECTION E: BIDDER'S ACKNOWLEDGEMENT E-1
SECTION F: BEST VALUE CONTRACTING F-1
SECTION G: BID BOND G-1
SECTION H: AGREEMENT H-1
SECTION I: PAYMENT AND PERFORMANCE BOND I-1

This Proposal, and Agreement have
been prepared by:

**CITY ENGINEERING DIVISION
CITY OF MADISON
MADISON, DANE COUNTY, WISCONSIN**



bn Robert F. Phillips, P.E., City Engineer

RFP: sms

SECTION A: ADVERTISEMENT FOR BIDS AND INSTRUCTIONS TO BIDDERS

REQUEST FOR BID FOR PUBLIC WORKS CONSTRUCTION CITY OF MADISON, WISCONSIN

A BEST VALUE CONTRACTING MUNICIPALITY

PROJECT NAME:	CHIP SEALING 2018 - EAST
CONTRACT NO.:	8093
SBE GOAL	4%
BID BOND	5%
SBE PRE BID MEETING (1:00 P.M.)	APRIL 6, 2018
PREQUALIFICATION APPLICATION DUE (2:00 P.M.)	APRIL 5, 2018
BID SUBMISSION (2:00 P.M.)	APRIL 12, 2018
BID OPEN (2:30 P.M.)	APRIL 12, 2018
PUBLISHED IN WSJ	MARCH 29 & APRIL 5, 2018

SBE PRE BID MEETING: Representatives of the Affirmative Action Department will be present to discuss the Small Business Enterprise requirements at 1600 Emil Street, Madison Wisconsin.

PREQUALIFICATION APPLICATION: Forms are available on our website, www.cityofmadison.com/business/pw/forms.cfm. If not currently prequalified in the categories listed in Section A, an amendment to your Prequalification will need to be submitted prior to the same due date. Postmark is not applicable.

BIDS TO BE SUBMITTED by hand to 1600 EMIL ST., MADISON, WI 53713 or online at www.bidexpress.com.

THE BID OPENING is at 1600 EMIL ST., MADISON, WI 53713.

STANDARD SPECIFICATIONS

The City of Madison's Standard Specifications for Public Works Construction - 2018 Edition, as supplemented and amended from time to time, forms a part of these contract documents as if attached hereto.

These standard specifications are available on the City of Madison Public Works website, www.cityofmadison.com/Business/PW/specs.cfm.

The Contractor shall review these Specifications prior to preparation of proposals for the work to be done under this contract, with specific attention to Article 102, "BIDDING REQUIREMENTS AND CONDITIONS" and Article 103, "AWARD AND EXECUTION OF THE CONTRACT." For the convenience of the bidder, below are highlights of three subsections of the specifications.

SECTION 102.1: PRE-QUALIFICATION OF BIDDERS

In accordance with Wisconsin State Statutes 66.0901 (2) and (3), all bidders must submit to the Board of Public Works proof of responsibility on forms furnished by the City. The City requires that all bidders be qualified on a biennial basis.

Bidders must present satisfactory evidence that they have been regularly engaged in the type of work specified herein and they are fully prepared with necessary capital, materials, machinery and supervisory personnel to conduct the work to be contracted for to the satisfaction of the City. All bidders must be pre-qualified by the Board of Public Works for the type of construction on which they are bidding prior to the opening of the bid.

In accordance with Section 39.02(9)(a)l. of the General Ordinances, all bidders shall submit in writing to the Affirmative Action Division Manager of the City of Madison, a Certificate of Compliance or an Affirmative Action Plan at the same time or prior to the submission of the proof of responsibility forms.

The bidder shall be disqualified if the bidder fails to or refuses to, prior to opening of the bid, submit a Certificate of compliance, Affirmative Action Plan or Affirmative Action Data Update, as applicable, as defined by Section 39.02 of the General Ordinances (entitled Affirmative Action) and as required by Section 102.11 of the Standard Specifications.

SECTION 102.4 PROPOSAL

No bid will be accepted that does not contain an adequate or reasonable price for each and every item named in the Schedule of Unit Prices.

A lump sum bid for the work in accordance with the plans and specifications is required. The lump sum bid must be the same as the total amounts bid for the various items and it shall be inserted in the space provided.

All papers bound with or attached to the proposal form are considered a part thereof and must not be detached or altered when the proposal is submitted. The plans, specifications and other documents designated in the proposal form will be considered a part of the proposal whether attached or not.

A proposal submitted by an individual shall be signed by the bidder or by a duly authorized agent. A proposal submitted by a partnership shall be signed by a member/partner or by a duly authorized agent thereof. A proposal submitted by a corporation shall be signed by an authorized officer or duly authorized registered agent of such corporation, and the proposal shall show the name of the State under the laws of which such corporation was chartered. The required signatures shall in all cases appear in the space provided thereof on the proposal.

Each proposal shall be placed, together with the proposal guaranty, in a sealed envelope, so marked as to indicate name of project, the contract number or option to which it applies, and the name and address of the Contractor or submitted electronically through Bid Express (www.bidexpress.com). Proposals will be accepted at the location, the time and the date designated in the advertisement. Proposals received after the time and date designated will be returned to the bidder unopened.

SECTION 102.5: BID DEPOSIT (PROPOSAL GUARANTY)

All bids, sealed or electronic, must be accompanied with a Bid Bond equal to at least 5% of the bid or a Certificate of Annual/Biennial Bid Bond or certified check, payable to the City Treasurer. Bid deposit of the successful bidders shall be returned within forty-eight (48) hours following execution of the contract and bond as required.

MINOR DISCREPENCIES

Bidder is responsible for submitting all forms necessary for the City to determine compliance with State and City bidding requirements. Notwithstanding any language to the contrary contained herein, the City may exercise its discretion to allow bidders to correct or supplement submissions after bid opening, if the minor discrepancy, bid irregularity or omission is insignificant and not one related to price, quality, quantity, time of completion or performance of the contract.

Bidders for this Contract(s) must be Pre-Qualified for at least one of the following type(s) of construction denoted by an

Building Demolition

- 101 Asbestos Removal
 120 House Mover

- 110 Building Demolition

Street, Utility and Site Construction

- 201 Asphalt Paving
 205 Blasting
 210 Boring/Pipe Jacking
 215 Concrete Paving
 220 Con. Sidewalk/Curb & Gutter/Misc. Flat Work
 221 Concrete Bases and Other Concrete Work
 222 Concrete Removal
 225 Dredging
 230 Fencing
 235 Fiber Optic Cable/Conduit Installation
 240 Grading and Earthwork
 241 Horizontal Saw Cutting of Sidewalk
 242 Infrared Seamless Patching
 245 Landscaping, Maintenance
 246 Ecological Restoration
 250 Landscaping, Site and Street
 251 Parking Ramp Maintenance
 252 Pavement Marking
 255 Pavement Sealcoating and Crack Sealing
 260 Petroleum Above/Below Ground Storage Tank Removal/Installation
 262 Playground Installer

- 265 Retaining Walls, Precast Modular Units
 270 Retaining Walls, Reinforced Concrete
 275 Sanitary, Storm Sewer and Water Main Construction
 276 Sawcutting
 280 Sewer Lateral Drain Cleaning/Internal TV Insp.
 285 Sewer Lining
 290 Sewer Pipe Bursting
 295 Soil Borings
 300 Soil Nailing
 305 Storm & Sanitary Sewer Laterals & Water Svc.
 310 Street Construction
 315 Street Lighting
 318 Tennis Court Resurfacing
 320 Traffic Signals
 325 Traffic Signing & Marking
 332 Tree pruning/removal
 333 Tree, pesticide treatment of
 335 Trucking
 340 Utility Transmission Lines including Natural Gas, Electrical & Communications
 399 Other _____

Bridge Construction

- 501 Bridge Construction and/or Repair

Building Construction

- 401 Floor Covering (including carpet, ceramic tile installation, rubber, VCT)
 402 Building Automation Systems
 403 Concrete
 404 Doors and Windows
 405 Electrical - Power, Lighting & Communications
 410 Elevator - Lifts
 412 Fire Suppression
 413 Furnishings - Furniture and Window Treatments
 415 General Building Construction, Equal or Less than \$250,000
 420 General Building Construction, \$250,000 to \$1,500,000
 425 General Building Construction, Over \$1,500,000
 428 Glass and/or Glazing
 429 Hazardous Material Removal
 430 Heating, Ventilating and Air Conditioning (HVAC)
 433 Insulation - Thermal
 435 Masonry/Tuck pointing

- 437 Metals
 440 Painting and Wallcovering
 445 Plumbing
 450 Pump Repair
 455 Pump Systems
 460 Roofing and Moisture Protection
 464 Tower Crane Operator
 461 Solar Photovoltaic/Hot Water Systems
 465 Soil/Groundwater Remediation
 466 Warning Sirens
 470 Water Supply Elevated Tanks
 475 Water Supply Wells
 480 Wood, Plastics & Composites - Structural & Architectural
 499 Other _____

State of Wisconsin Certifications

- 1 Class 5 Blaster - Blasting Operations and Activities 2500 feet and closer to inhabited buildings for quarries, open pits and road cuts.
 2 Class 6 Blaster - Blasting Operations and Activities 2500 feet and closer to inhabited buildings for trenches, site excavations, basements, underwater demolition, underground excavations, or structures 15 feet or less in height.
 3 Class 7 Blaster - Blasting Operations and Activities for structures greater than 15' in height, bridges, towers, and any of the objects or purposes listed as "Class 5 Blaster or Class 6 Blaster".
 4 Petroleum Above/Below Ground Storage Tank Removal and Installation (Attach copies of State Certifications.)
 5 Hazardous Material Removal (Contractor to be certified for asbestos and lead abatement per the Wisconsin Department of Health Services, Asbestos and Lead Section (A&LS).) See the following link for application: www.dhs.wisconsin.gov/Asbestos/Cert. State of Wisconsin Performance of Asbestos Abatement Certificate must be attached.
 6 Certification number as a Certified Arborist or Certified Tree Worker as administered by the International Society of Arboriculture
 7 Pesticide application (Certification for Commercial Applicator For Hire with the certification in the category of turf and landscape (3.0) and possess a current license issued by the DATCP)
 8 State of Wisconsin Master Plumbers License.

SECTION B: PROPOSAL

Please refer to the
Bid Express Website
at <https://bidexpress.com>
look up contract number
and go to
Section B: Proposal Page

You can access all City of Madison bid solicitations for FREE at www.bidexpress.com

Click on the "Register for Free" button and follow the instructions to register your company and yourself. You will be asked for a payment subscription preference, since you may wish to bid online someday. Simply choose the method to pay on a 'per bid' basis. This requires no payment until / unless you actually bid online. You can also choose the monthly subscription plan at this time. You will, however, be asked to provide payment information. Remember, you can change your preference at anytime. You will then be able to complete your free registration and have full access to the site. Your free access does not require completion of the 'Digital ID' process, so you will have instant access for viewing and downloading. To be prepared in case you ever do wish to bid online, you may wish to establish your digital ID also, since you cannot bid without a Digital ID.

If you have any problems with the free registration process, you can call the bidexpress help team, toll free at 1-888-352-2439 (option 1, option1).

SECTION C: SMALL BUSINESS ENTERPRISE

Instructions to Bidders City of Madison SBE Program Information

2 Small Business Enterprise (SBE) Program Information

2.1 Policy and Goal

The City of Madison reaffirms its policy of nondiscrimination in the conduct of City business by maintaining a procurement process which remains open to all who have the potential and ability to sell goods and services to the City. It is the policy of the City of Madison to allow Small Business Enterprises (SBE) maximum feasible opportunity to participate in City of Madison contracting. The bidder acknowledges that its bid has been submitted in accordance with the SBE program and is for the public's protection and welfare.

Please refer to the "ADVERTISEMENT FOR BIDS" for the goal for the utilization of SBEs on this project. SBEs may participate as subcontractors, vendors and/or suppliers, which provide a commercially useful function. The dollar value for SBE suppliers or 'materials only' vendors shall be discounted to 60% for purposes of meeting SBE goals.

A bidder which achieves or exceeds the SBE goal will be in compliance with the SBE requirements of this project. In the event that the bidder is unable to achieve the SBE goal, the bidder must demonstrate that a good faith effort to do so was made. Failure to either achieve the goal or demonstrate a good faith effort to do so will be grounds for the bidder being deemed a non-responsible contractor ineligible for award of this contract.

A bidder may count towards its attainment of the SBE goal only those expenditures to SBEs that perform a commercially useful function. For purposes of evaluating a bidder's responsiveness to the attainment of the SBE goal, the contract participation by an SBE is based on the percentage of the total base bid proposed by the Contractor. The total base bid price is inclusive of all addenda.

Work performed by an SBE firm in a particular transaction can be counted toward the goal only if it involves a commercially useful function. That is, in light of industry practices and other relevant considerations, does the SBE firm have a necessary and useful role in the transaction, of a kind for which there is a market outside the context of the SBE Program, or is the firm's role a superfluous step added in an attempt to obtain credit towards goals? If, in the judgment of the Affirmative Action Division, the SBE firm will not perform a commercially useful function in the transaction, no credit towards goals will be awarded.

The question of whether a firm is performing a commercially useful function is completely separate from the question of whether the firm is an eligible SBE. A firm is eligible if it meets the definitional criteria and ownership and control requirements, as set forth in the City of Madison's SBE Program.

If the City of Madison determines that the SBE firm is performing a commercially useful function, then the City of Madison must then decide what that function is. If the commercially useful function is that of an SBE vendor / supplier that regularly transacts business with the respective product, then the City of Madison will count 60% of the value of the product supplied toward SBE goals.

To be counted, the SBE vendor / supplier must be engaged in selling the product in question to the public. This is important in distinguishing an SBE vendor / supplier, which has a regular trade with a variety of customers, from a firm which performs supplier-like functions on an ad hoc basis or for only one or two contractors with whom it has a special relationship.

A supplier of bulk goods may qualify as an eligible SBE vendor / supplier if it either maintains an inventory or owns or operates distribution equipment. With respect to the distribution equipment; e.g., a fleet of trucks, the term "operates" is intended to cover a situation in which the supplier leases the equipment on a regular basis for its entire business. It is not intended to cover a situation in which the firm simply provides drivers for trucks owned or leased by another party; e.g., a prime contractor, or leases such a party's trucks on an ad hoc basis for a specific job.

If the commercially useful function being performed is not that of a qualified SBE vendor / supplier, but rather that of delivery of products, obtaining bonding or insurance, procurement of personnel, acting as a broker or manufacturer's representative in the procurement of supplies, facilities, or materials, etc., only the fees or commissions will apply towards the goal.

For example, a business that simply transfers title of a product from manufacturer to ultimate purchaser; e. g., a sales representative who re-invoices a steel product from the steel company to the Contractor, or a firm that puts a product into a container for delivery would not be considered a qualified SBE vendor / supplier. The Contractor would not receive credit based on a percentage of the cost of the product for working with such firms.

Concerning the use of services that help the Contractor obtain needed supplies, personnel, materials or equipment to perform a contract: only the fee received by the service provider will be counted toward the goal. For example, use of a SBE sales representative or distributor for a steel company, if performing a commercially useful function at all, would entitle the Contractor receiving the steel to count only the fee paid to the representative or distributor toward the goal. This provision would also govern fees for professional and other services obtained expressly and solely to perform work relating to a specific contract.

Concerning transportation or delivery services: if an SBE trucking company picks up a product from a manufacturer or a qualified vendor / supplier and delivers the product to the Contractor, the commercially useful function it is performing is not that of a supplier, but simply that of a transporter of goods. Unless the trucking company is itself the manufacturer or a qualified vendor / supplier in the product, credit cannot be given based on a percentage of the cost of the product. Rather, credit would be allowed for the cost of the transportation service.

The City is aware that the rule's language does not explicitly mention every kind of business that may contribute work on this project. In administering these programs, the City would, on a case-by-case basis, determine the appropriate counting formula to apply in a particular situation.

2.2 Contract Compliance

Questions concerning the SBE Program shall be directed to the Contract Compliance Officer of the City of Madison Department of Civil Rights, Affirmative Action Division, 210 Martin Luther King, Jr. Blvd., Room 523, Madison, WI 53703; telephone (608) 266-4910.

2.3 Certification of SBE by City of Madison

The Affirmative Action Division maintains a directory of SBEs which are currently certified as such by the City of Madison. Contact the Contract Compliance Officer as indicated in Section 2.2 to receive a copy of the SBE Directory or you may access the SBE Directory online at www.cityofmadison.com/dcr/aaTBDDir.cfm.

All contractors, subcontractors, vendors and suppliers seeking SBE status must complete and submit the **Targeted Business Certification Application** to the City of Madison Affirmative Action Division by the time and date established for receipt of bids. A copy of the Targeted Business Certification Application is available by contacting the Contract Compliance Officer at the address and telephone indicated in Section 2.2 or you may access the Targeted Business Certification Application online at www.cityofmadison.com/dcr/aaTBDDir.cfm. Submittal of the Targeted Business Certification Application by the time specified does not guarantee that the applicant will be certified as a SBE eligible to be utilized towards meeting the SBE goal for this project.

2.4 Small Business Enterprise Compliance Report

2.4.1 Good Faith Efforts

Bidders shall take all necessary affirmative steps to assure that SBEs are utilized when possible and that the established SBE goal for this project is achieved. A contractor who self performs a portion of the work, and is pre-qualified to perform that category of work, may subcontract that portion of the work, but shall not be required to do so. When a bidder is unable to achieve the established SBE goal, the bidder must demonstrate that a good faith effort to do so was made. Such a good faith effort should include the following:

- 2.4.1.1 Attendance at the pre-bid meeting.
- 2.4.1.2 Using the City of Madison's directory of certified SBEs to identify SBEs from which to solicit bids.
- 2.4.1.3 Assuring that SBEs are solicited whenever they are potential sources.
- 2.4.1.4 Referring prospective SBEs to the City of Madison Affirmative Action Division for certification.
- 2.4.1.5 Dividing total project requirements into smaller tasks and/or quantities, where economically feasible, to permit maximum feasible SBE participation.
- 2.4.1.6 Establishing delivery schedules, where requirements permit, which will encourage participation by SBEs.
- 2.4.1.7 Providing SBEs with specific information regarding the work to be performed.
- 2.4.1.8 Contacting SBEs in advance of the deadline to allow such businesses sufficient time to prepare a bid.
- 2.4.1.9 Utilizing the bid of a qualified and competent SBE when the bid of such a business is deemed reasonable (i.e. 5% above the lowest bidder), although not necessarily low.
- 2.4.1.10 Contacting SBEs which submit a bid, to inquire about the details of the bid and confirm that the scope of the work was interpreted as intended.
- 2.4.1.11 Completion of Cover Page (page C-6), Summary Sheet (page C-7) and SBE Contact Reports (pages C-8 and C9) if applicable.

2.4.2 Reporting SBE Utilization and Good Faith Efforts

The Small Business Enterprise Compliance Report is to be submitted by the bidder with the bid: This report is due by the specified bid closing time and date. Bids submitted without a completed SBE Compliance Report as outlined below may be deemed non-responsible and the bidder ineligible for award of this contract. Notwithstanding any language to the contrary contained herein, the City may exercise its discretion to allow bidders to correct or supplement submissions after bid opening, if the minor discrepancy, bid irregularity or omission is insignificant and not one related to price, quality, quantity, time of completion, performance of the contract, or percentage of SBE utilization.

2.4.2.1 If the Bidder meets or exceeds the goal established for SBE utilization, the Small Business Enterprise Compliance Report shall consist of the following:

2.4.2.1.1 **Cover Page**, Page C-6; and

2.4.2.1.2 **Summary Sheet**, C-7.

2.4.2.2 If the bidder does not meet the goal established for SBE utilization, the Small Business Enterprise Compliance Report shall consist of the following:

2.4.2.2.1 **Cover Page**, Page C-6;

2.4.2.2.2 **Summary Sheet**, C-7; and

2.4.2.2.3 **SBE Contact Report**, C-8 and C-9. (A separate Contact Report must be completed for each applicable SBE which is not utilized.)

2.5 Appeal Procedure

A bidder which does not achieve the established goal and is found non-responsible for failure to demonstrate a good faith effort to achieve such goal and subsequently denied eligibility for award of contract may appeal that decision to the Small Business Enterprises Appeals Committee. All appeals shall be made in writing, and shall be delivered to and received by the City Engineer no later than 4:30 PM on the third business day following the bidder's receipt of the written notification of ineligibility by the Affirmative Action Division Manager. Postmark not acceptable. The notice of appeal shall state the basis for the appeal of the decision of the Affirmative Action Division Manager. The Appeal shall take place in accordance with Madison General Ordinance 33.54.

2.6 SBE Requirements After Award of the Contract

The successful bidder shall identify SBE subcontractors, suppliers and vendors on the subcontractor list in accordance with the specifications. The Contractor shall submit a detailed explanation of any variances between the listing of SBE subcontractors, vendors and/or suppliers on the subcontractor list and the Contractor's SBE Compliance Report for SBE participation.

No change in SBE subcontractors, vendors and/or suppliers from those SBEs indicated in the SBE Compliance Report will be allowed without prior approval from the Engineer and the Affirmative Action Division. The contractor shall submit in writing to the City of Madison Affirmative Action Division a request to change any SBE citing specific reasons which necessitate such a change. The Affirmative Action Division will use a general test of reasonableness in approving or rejecting the contractor's request for change. If the request is approved, the Contractor will make every effort to utilize another SBE if available.

The City will monitor the project to ensure that the actual percentage commitment to SBE firms is carried out.

2.7 SBE Definition and Eligibility Guidelines

A Small Business Enterprise is a business concern awarded certification by the City of Madison. For the purposes of this program a Small Business Enterprise is defined as:

- A. An independent business operated under a single management. The business may not be a subsidiary of any other business and the stock or ownership may not be held by any individual or any business operating in the same or a similar field. In determining whether an entity qualifies as a SBE, the City shall consider all factors relevant to being an independent business including, but not limited to, the date the business was established, adequacy of its resources for the work in which it proposes to involve itself, the degree to which financial, equipment leasing and other relationships exist with other ineligible firms in the same or similar lines of work. SBE owner(s) shall enjoy the customary incidents of ownership and shall share in the risks and profits commensurate with their enjoyment interests, as demonstrated by an examination of the substance rather than form or arrangements that may be reflected in its ownership documents.
- B. A business that has averaged no more than \$4.0 million in annual gross receipts over the prior three year period and the principal owner(s) do not have a personal net worth in excess of \$1.32 million.

Firm and/or individuals that submit fraudulent documents/testimony may be barred from doing business with the City and/or forfeit existing contracts.

SBE certification is valid for one (1) year unless revoked.

SECTION D: SPECIAL PROVISIONS

CHIP SEALING 2018 - EAST CONTRACT NO. 8093

It is the intent of these Special Provisions to set forth the final contractual intent as to the matter involved and shall prevail over the Standard Specifications and plans whenever in conflict therewith. In order that comparisons between the Special Provisions can be readily made, the numbering system for the Special Provisions is equivalent to that of the Specifications.

Whenever in these Specifications the term "Standard Specifications" appears, it shall be taken to refer to the City of Madison Standard Specifications for Public Works Construction and Supplements thereto.

SECTION 102.12: BEST VALUE CONTRACTING

This Contract shall be considered a Best Value Contract if the Contractor's bid is equal to or greater than \$61,000 for a single trade contract; or equal to or greater than \$297,500 for a multi-trade contract pursuant to MGO 33.07(7).

ARTICLE 104 SCOPE OF WORK

The work under this contract consists street sweeping and cleaning of all loose material, vegetation and other objectionable material, the protection of inlets and castings and chip sealing. It is the Contractors responsibility to find locations to stockpile all required materials and dispose of all swept and waste material. The stockpiles may not be stored within the City of Madison's street right-of-way. **The street sweeping shall be the Contractor's responsibility. The City will no longer sweep after the Contractors first sweeping. This WILL require multiple sweepings to clean up ALL the loose aggregate.**

NO Chip sealing shall occur on Fridays unless approved by the Engineer. All streets shall be swept by Friday night at 7 pm each week.

Any street segment labeled with an **Asterisk (*)** on the proposal pages **shall** require pavement marking removal.

The Contractor shall be required to sweep ALL sealed streets and side streets where tracking may occur outside the limits of chip sealing. ALL loose aggregate left from the chip sealing application shall be the Contractors responsibility. This may require more than one sweeping. If sweeping becomes an issue, the Engineer may halt all sealing operations until the sweeping meets the Engineers satisfaction.

The Contractor shall supply the city with samples of the aggregate and emulsion for testing purposes prior to starting work. The Contract shall supply the material in a timely manner to allow the City to accomplish the testing before any work begins.

SECTION 104.6 DECREASED AND DELETED ITEMS

The City of Madison reserves the right to delete any street segment they deem necessary. Such deletion shall not constitute the basis for a claim for damages for anticipated profits for the work dispensed with.

SECTION 107.7 MAINTENANCE OF TRAFFIC

All traffic control shall conform to Part VI of the Federal Highways Administrations "Manual on Uniform Traffic Control Devices" (MUTCD), the State of Wisconsin Standard Facilities Development Manual (including Chapter 16 – Standard Detail Drawings) and the City of Madison Standards for sidewalk and bikeway closures.

The Contractor shall submit a schedule of work to the office of the City Traffic Engineer, a minimum of 48 hours prior to the start of work on this project.

Streets shall remain open to traffic at all times. This will require the use of properly equipped flag persons. On multi lane roadways, lane closures are permitted, using the traffic control as established by the MUTCD.

The Contractor may remove parking within the construction limits between the hours of 7:00 a.m. and 6:00 p.m. to facilitate construction on this project. Removal of parking between the hours of 6:00 p.m. and 7:00 a.m. is subject to approval City Traffic Engineering. The city will supply the contractor with the no parking signs. Please see the "Guideline for Temporary No Parking Restrictions for Construction or Special Events" contained in these special provisions.

If a street is posted with no parking signs and no work has occurred within 4 days of the posting. The Contractor **WILL** be required to remove the no parking posting, restore parking and repost the street for sealing at a later date.

The Contractor shall provide pedestrian access that is Handicap Accessible across each intersection at all times.

Access to adjacent properties shall be maintained at all times.

Peak hour restrictions shall apply for the below mentioned streets. Peak hours shall be defined as Monday through Friday between the hours of 7 A.M. and 9 A.M. and 3 P.M. to 6 P.M. Peak

The Contractor shall **only** chip seal one half of the street at a time and use arrow boards to direct traffic when Chip sealing due to bus traffic and traffic volume. The Contractor shall also have several flaggers available and on site when sealing the following streets to assist in the traffic control for the streets listed below:

American Pkwy
Anniversary Ln.
Bartillon Dr.
Buttonwood Dr.
City View Dr.
Davies St.
Dempsey Rd.
Dwight Dr.
East Terrace Dr.
East Town Blvd.
Hayes Rd.
Lien Rd.
Melody Ln.
N Biltmore Ln.
West Terrace Dr.

The Contractor shall maintain warning signs for "loose gravel" on ALL streets until the Contractor has swept the completed Chip Sealed Street.

SECTION 109.2 PROSECUTION OF WORK

Work shall begin only after the start work letter is received. The Contractor shall be required to limit workdays to 7:00 PM and work shall not be performed on holidays.

The contractor must consult the Engineer about the proposed schedule for the work to be done under this contract, to assure there will not be any conflicts with other city projects. Each time, work is resumed; the Contractor shall notify the Engineer at least seventy-two (72) hours in advance of beginning work. During periods of work, the Contractor shall provide the Engineer a schedule of the work such that the Engineer

is able to inspect the daily progress of the contract, and allow the Engineer to alter the contractors schedule to avoid potential conflicts with other city projects.

SECTION 109.7 TIME OF COMPLETION

The Contractor shall complete all work specified in this contract on or before JULY 31, 2018.

SECTION 109.9 LIQUIDATED DAMAGES

Liquidated damages shall be assessed in accordance with the City of Madison standard specifications.

Additional liquidated damages shall be assessed to the Contractor if the inlet protection is not removed within 7 days of the final sweeping. For every day after the 7 days the inlet protection is not removed the Contractor shall be assessed \$100 in liquidated damages per inlet per day that the inlet protection is not removed.

Additional liquidated damages shall be assessed to the Contractor for each street that is not swept within 2 days (48 hours) of chip sealing the street. For every day after the 2 days (48 hours) each street is not swept in accordance with these specifications, the Contractor shall be assessed \$250 in liquidated damages per street per day.

BID ITEM 21041 INLET PROTECTION, TYPE D – COMPLETE (UNDISTRIBUTED)

DESCRIPTION

This item is undistributed and may or may not be used. It is intended for use at low points of the road when the chip sealing may occur with rain in the forecast. The Engineer will notify the Contractor where and when; Type D inlet protection should be installed.

Work under this item shall include all work, materials, labor and incidentals necessary for installing, maintaining, and removing the Inlet Protection Type D device.

The Contractor shall be responsible at a minimum to inspect weekly and within 24 hours after every precipitation event that produces 0.5 inches of rain or more during a 24-hour period. The Contractor shall remove sediment deposits, dispose of sediment, and restore device to its original dimension after accumulation of sediment is between one-third (1/3) to one-half (1/2) the design depth of the device. The contractor shall replace a non-operating device with a new device that will be considered incidental. The Contractor shall take care to ensure sediment does not fall within the inlet. If sediment does fall within the inlet, the Contractor shall be responsible for removing and disposing of the sediment.

METHOD OF MEASUREMENT

Inlet Protection, Type D - Complete shall be measured as each acceptably completed and approved by the Construction Engineer.

BASIS OF PAYMENT

Inlet Protection, Type D - Complete shall be measured as described above which shall be full compensation for all work, materials, and incidentals to complete the work as described above.

SECTION 408.1 MATERIALS FOR PAVEMENT CHIP SEALING

The aggregate for the Chip Seal shall be Class A, Granite, and shall be grey in color or an approved equivalent. The gradation for the material shall conform to the following requirements:

SIEVE SIZE	PERCENT(%) PASSING BY WEIGHT	TOLERANCE %
1/2 inch(12.5 mm)	100	----
3/8 inch(9.5 mm)	100	± 5
1/4 inch(6.3 mm)	100	± 7
No. 4(4.75 mm)	0 - 100	± 7
No. 8(2.36 mm)	0 - 40	± 4
No.16(1.18 mm)	0 - 10	± 4
No. 50(300 µm)	0 - 5	± 4
No. 100(150 µm)	----	± 4
No. 200(75 µm)	0.0 – 1.0	----

Chip Sealing and Seal Coat are considered to be one and the same for these special provisions. The Chip Seal shall conform to Section 475 "Seal Coat" of the "Standard Specifications for Highway and Structure Construction" prepared by the State of Wisconsin Department of Transportation and these special provisions herein set forth shall govern this construction.

The asphaltic material for the Chip Seal shall be CRS-2P; Polymer modified, and be applied at a rate of 0.30-0.32 gallons per square yard. This asphaltic material shall be rapid set emulsion that has elastic properties and shall comply with AASHTO M316.

The temperature of the Asphaltic Emulsion at the time of application shall not be less than 150 degrees Fahrenheit or more than 180 degrees Fahrenheit.

The aggregate for the Chip Seal shall be Class A, Granite, and shall be grey in color or an approved equivalent. The Gradation for the material shall conform to the following requirements:

The Contractor will be required to supply a sample to the Engineer prior to the start of work. The Contractor shall also submit written verification from their Supplier that the asphalt emulsion and aggregate properly bond. Should there be any discrepancies in the field; the Contractor shall be responsible for all costs associated with repairs. The application rates for the screenings and Asphaltic Emulsion shall be within the range specified in the following table.

	SCREENING (LB/S.Y.)	ASPHALTIC EMULSION (GAL. /S.Y.)
Single Chip Seal	20 TO 22	0.30-0.32

SECTION 408.2 PERSONNEL

The Contractor's personnel shall be experienced in Chip Sealing work and shall be knowledgeable regarding the material and equipment to be used for Chip Sealing.

SECTION 408.3 EQUIPMENT

The Contractor shall furnish all equipment necessary, but not be limited to the equipment specified in Section 475.3.2 of the WISDOT Standard Specifications.

The second paragraph of the WISDOT Standard Specifications, Section 475.3.5 "Applying and Rolling Seal Coat Aggregate" is amended to read as follows:

The Contractor shall furnish a minimum of two (2) pneumatic-tired rollers.

The initial rolling shall consist of one (1) complete coverage performed with a pneumatic-tired roller and shall begin immediately behind the spreader. Binder and screenings shall not be spread more than 500 feet ahead of completion of the initial rolling operations. Secondary rolling shall begin immediately after completion of the initial rolling. The amount of secondary rolling shall be sufficient to adequately seat the screenings and in no case shall be less than two (2) complete coverages.

The Contractor shall sweep the completed Chip Sealed streets within FORTY-EIGHT (48) hours after the second rolling or after the Chip Sealing is set whichever is sooner.

SECTION 408.4 PREPARATION OF THE SURFACE AND PROTECTION

Immediately before applying the Asphaltic Emulsion, the Contractor shall be responsible for removing all loose material, silt, clay, vegetation in the street and edge of gutter and other objectionable materials from the street with a power broom, street sweeper, edger or other approved method. **The Contractor shall install reflective tabs on the streets that have pavement marking prior to sealing streets. The tabs shall be installed on the existing pavement marking to notify the traffic of the lane delineations after the street has been sealed.**

Prior to Chip Sealing the Contractor shall protect all inlets contained within the Chip Sealing area and downstream inlets in accordance with Article 210 – EROSION CONTROL of the City of Madison's Standard Specifications and the WDNR Conservation Practice Standards, or as determined necessary by the Construction Engineer. WDNR Conservation Practice Standards referenced in these Standard Specifications are available on-line at http://dnr.wi.gov/topic/stormwater/standards/const_standards.html. Inlet protection shall be installed per WDNR Conservation Practice 1060 - Storm Drain Inlet Protection TYPE C for Construction Sites available on-line at http://dnr.wi.gov/topic/stormWater/documents/StormDrainInletProtectionConstructionSites_1060.pdf

It shall be the Contractors responsibility to locate and protect all utility castings including but not limited to sewer access structures, water valves, inlets, and catchbasins within the street or streets to be chip sealed prior to starting work and protect these castings so that **ABSOLUTELY NO ASPHALTIC EMULSION** will be applied. If castings are covered by chip sealing the Contractor will be responsible to clean and or replace the all the castings at their own expense, as required by the City Engineer. No work shall begin until all utility castings are protected. No work shall begin until all Traffic Control is in place as required in Section 107.7.

All inlet protection shall remain in place until the streets are swept to the satisfaction of the Engineer. Please note that BID ITEM 21041 INLET PROTECTION, TYPE D - COMPLETE is undistributed and may or may not be used. All other inlet protection is considered incidental to lump sum bid of chip sealing.

SECTION 408.5 METHOD OF MEASUREMENT

The Contractor shall bid each Street segment in the contract individually; based on the price to properly Chip Seal the street segment according to the conditions provided in this contract. Each segment will be bid as a "lump sum" price. It is the Contractors responsibility to review each street segment and verify the area to be chip sealed.

SECTION 408.6 BASIS OF PAYMENT

Chip Sealing will be paid for at the Contractors bid price per street segment. Which price shall be full compensation for furnishing; heating, unloading, hauling, and for applying the Chip Sealing material; for the cleaning of the streets, installing reflective tabs, applying the Asphalt Emulsion and Chips, Rolling, street sweeping; for locating stockpile locations and disposal of all waste material, for the protection of inlets and utility casting; and for all labor, tools, equipment, and incidental necessary to complete the work as provided in the contract.

ARTICLE 608 PAVEMENT MARKINGS

The streets listed below shall require Pavement marking removal as described. Removal of the lines shall be measures by the linear foot.

1. American Pkwy – all lane lines (6" White bike lane lines, 4" double yellow centerline, 6" White 10' Line x 30' Gap lane lines), from South End to Village Park Dr
2. American Pkwy –6" White 10' Line x 30' Gap lane lines, , 6" White 2' Line x 6' Gap lane lines, 8" White 2' Line x 6' Gap lane lines, from Village Park Dr to Hoepker Rd
3. Hoepker Rd – all lane lines (4" White edge lines, 6" White bike lane lines, 6" White 10' Line x 30' Gap lane lines, 6" White 2' Line x 6' Gap lane lines, 6" Yellow radius lines, 8" White 2' Line x 6' Gap lane lines and 8" White 5' Line x 5' Gap barrier guide lines), entire road way
4. Lien Rd – all lane lines (4" double yellow centerline, 6" White 10' Line x 30' Gap lane lines)
5. Thierer Rd – all lane lines (4" double yellow centerline, 6" White 10' Line x 30' Gap lane lines)
6. Kinsman Blvd – all lane lines (4" double yellow centerline, 6" White 10' Line x 30' Gap lane lines, 6" White bike lane lines, 8" White barrier lines)
7. Bartillon Dr – all lane lines (6" White bike lane lines and 4" double yellow centerline), to 450 feet north of Kinsman Blvd. 6" Yellow 10' Line x 30' Gap centerline, from Orin Rd to Anderson St
8. Mendota St – all lane lines (4" double yellow centerline, 6" Yellow 10' Line x 30' Gap centerline, 6" White 10' Line x 30' Gap lane lines, 6" White 2' Line x 6' Gap lane lines, 6" White bike lane lines)
9. Sycamore Ave – all lane lines (6" Yellow 10' Line x 30' Gap centerline, 6" Yellow 10' Line x 30' Gap centerline and 6" White bike lane lines)
10. Parkside Dr – all 6" Yellow 10' Line x 30' Gap centerline
11. Easttowne Blve – all 6" Yellow 10' Line x 30' Gap centerline and 4" double yellow centerline
12. Annamark Dr – all 6" Yellow 10' Line x 30' Gap centerline
13. Hayes Rd – all 6" Yellow 10' Line x 30' Gap centerline and 6" White 2' Line x 6' Gap lane lines
14. Crossroads Dr – all 6" Yellow 10' Line x 30' Gap centerline
15. City View Dr – all 6" Yellow 10' Line x 30' Gap centerline
16. Wall St – all 6" Yellow 10' Line x 30' Gap centerline
17. East/West Terrace Dr – all 6" Yellow 10' Line x 30' Gap centerline
18. North/South Biltmore Ln – all 6" Yellow 10' Line x 30' Gap centerline
19. Buttonwood Dr – all 6" Yellow 10' Line x 30' Gap centerline
20. Tancho Dr – all 6" Yellow 10' Line x 30' Gap centerline and 6" White 10' Line x 30' Gap lane lines

Epoxy pavement markings will be required as described in the pavement marking plans included in this contract.

CHIP SEALING 2018 - EAST

SCHEDULED STREETS

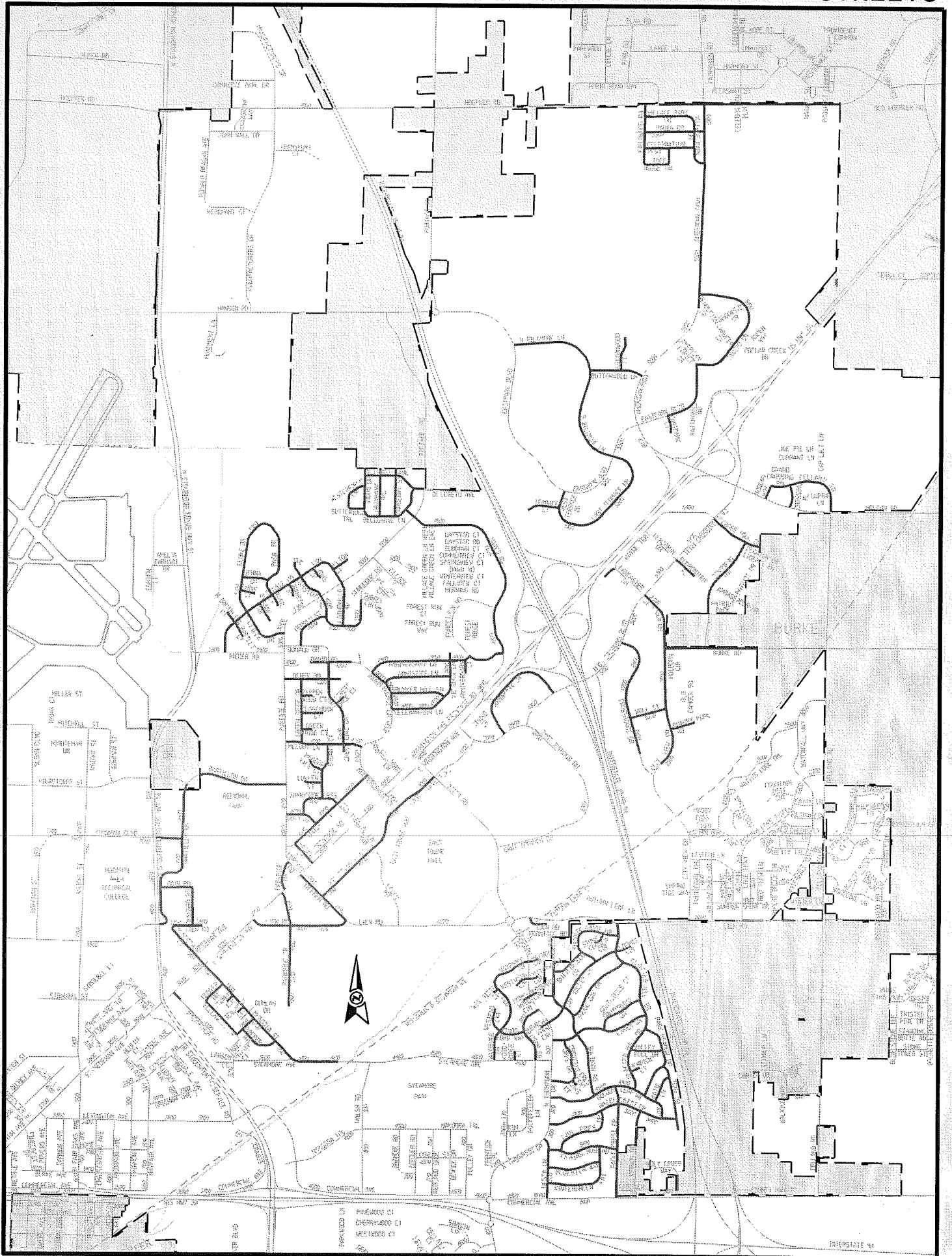

CHIP SEALING 2018 - EAST

SCHEDULED STREETS

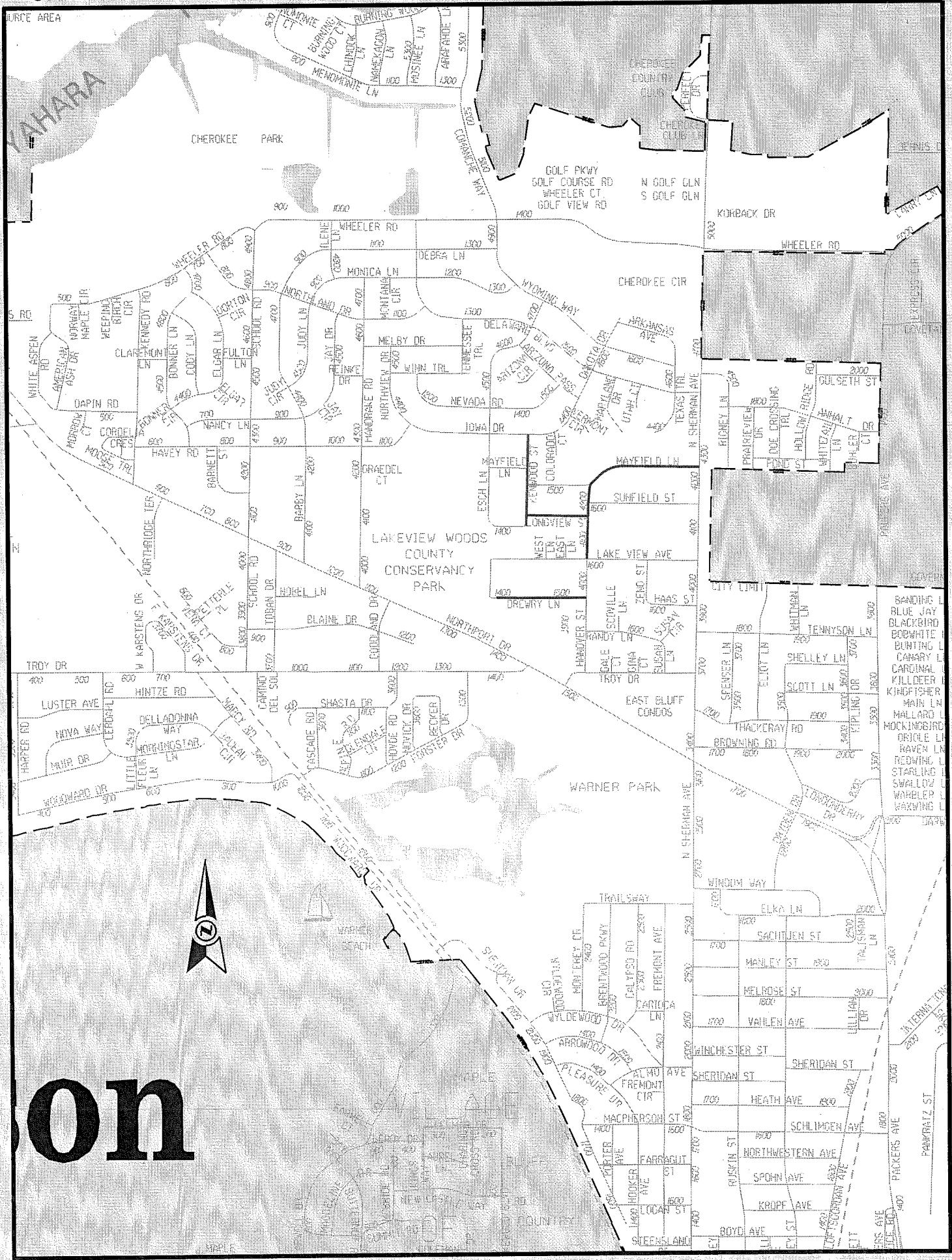

on



CHIP SEALING 2018 - EAST

SCHEDULED STREETS

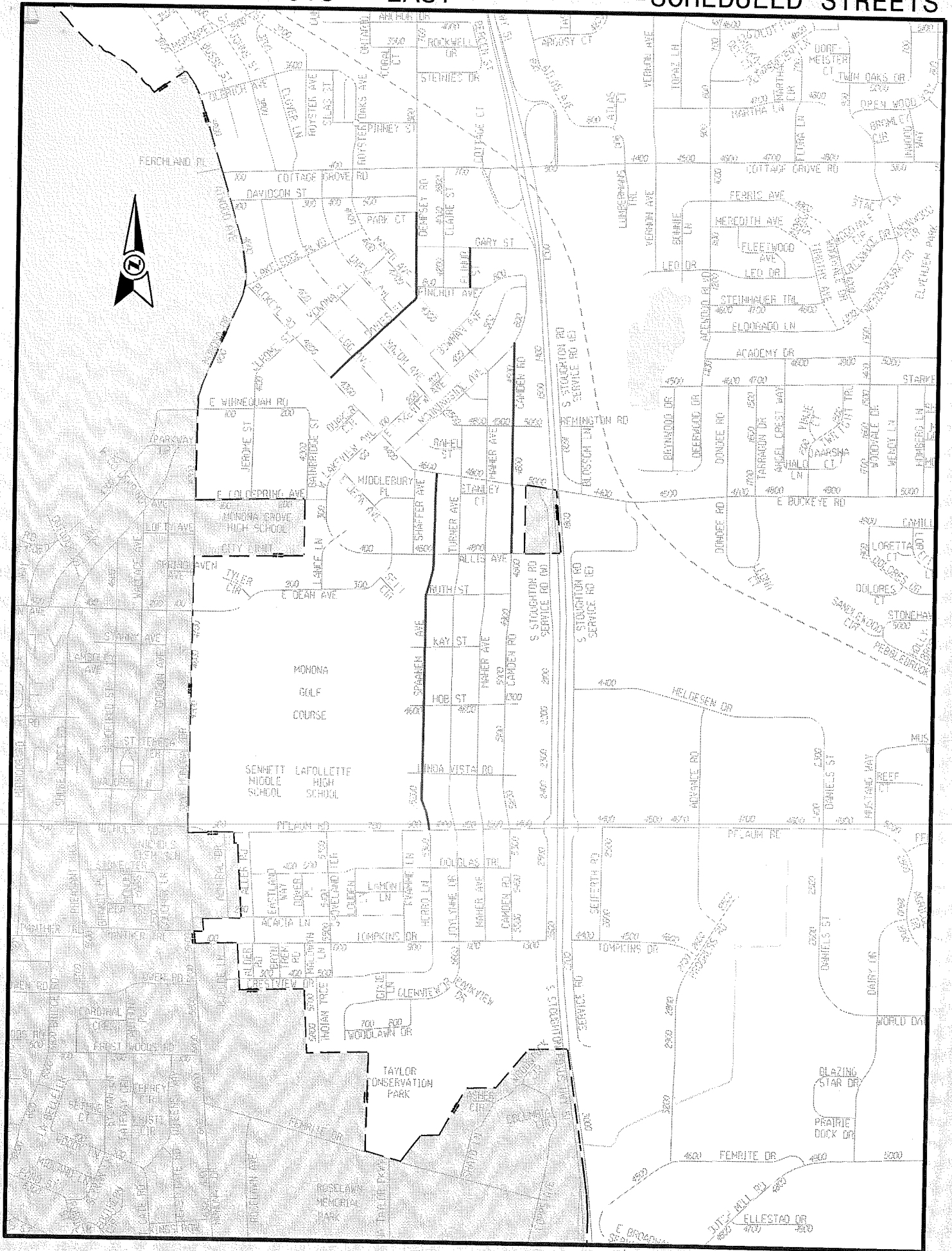

SCALE: 1" = 60'

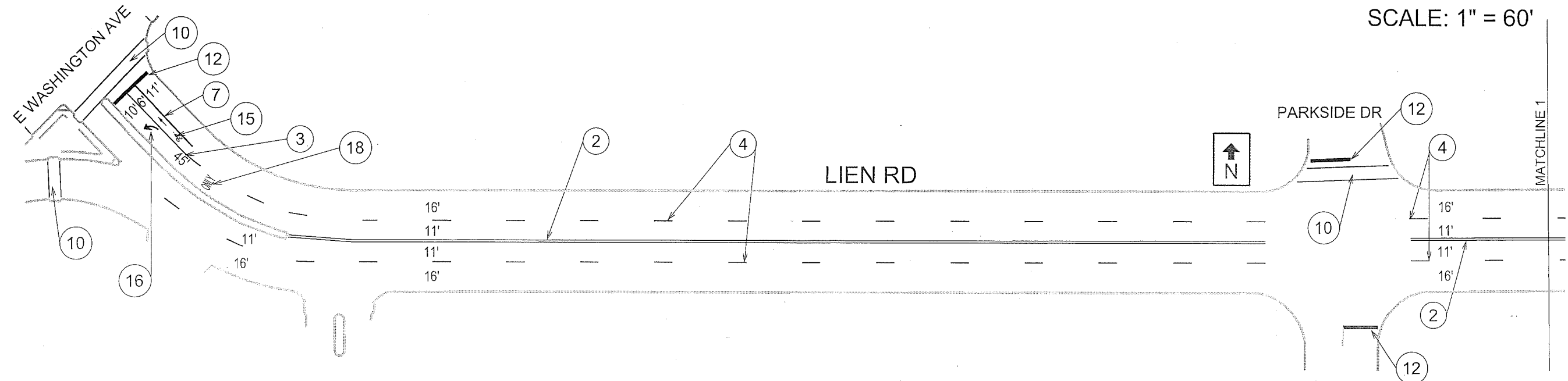

Callout	Bid Item	Description
1	60800	Pavement Marking Epoxy, 4-Inch, Solid White
2	60801	Pavement Marking Epoxy, 4-Inch Double Yellow
3	60802	Pavement Marking Epoxy, 6-Inch Solid White
4	60802	Pavement Marking Epoxy, 6-Inch White Skips, (10' Line, 30' Gap)
5	60802	Pavement Marking Epoxy, 6-Inch Yellow Skips (10' Line, 30' Gap)
6	60802	Pavement Marking Epoxy, 6-Inch White Skips, (2' Line, 6' Gap)
7	60803	Pavement Marking Epoxy, 8-Inch Solid White
8	60803	Pavement Marking Epoxy, 8-Inch White Skips, (5' Line, 5' Gap)
9	60803	Pavement Marking Epoxy, 8-Inch White Skips, (2' Line, 6' Gap)
10	60812	Pavement Marking Epoxy, 6-Inch White, Crosswalk
11	60815	Pavement Marking Epoxy, Continental Crosswalk, 18-Inch
12	60818	Pavement Marking Epoxy, 24-Inch White, Stop Line
13	60822	Pavement Marking Epoxy, Symbol, Bike Sharrow
14	60823	Pavement Marking Epoxy, Symbol, Bike Lane
15	60824	Pavement Marking Epoxy, Symbol, Bike Straight Arrow
16	60829	Pavement Marking Epoxy, Symbol, Left Arrow
17	60830	Pavement Marking Epoxy, Symbol, Right Arrow
18	60834	Pavement Marking Epoxy, Word, "ONLY"

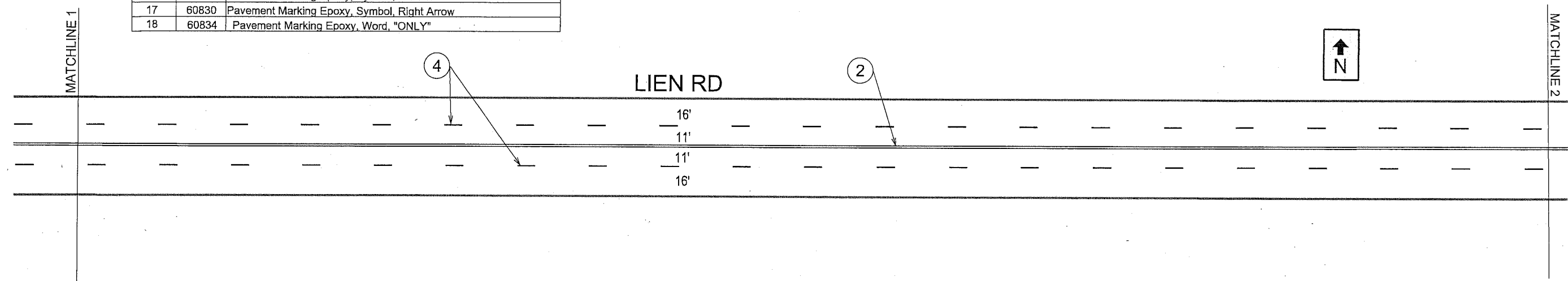

PLOT SCALE:

PLOT NAME:

REV. DATE:

ORIGINATOR: CITY OF MADISON, TRAFFIC ENG. DIV.

SCALE: 1" = 60'

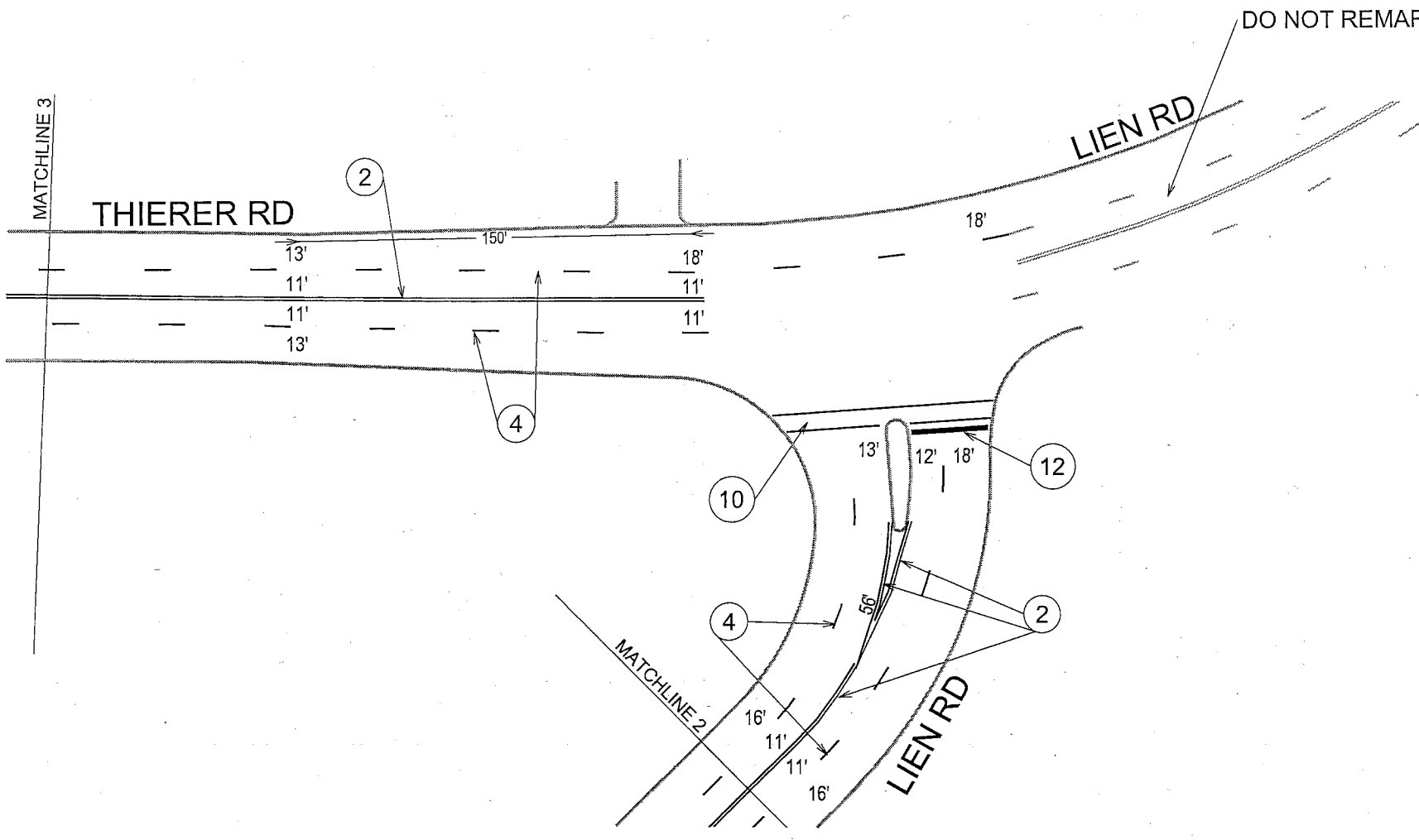
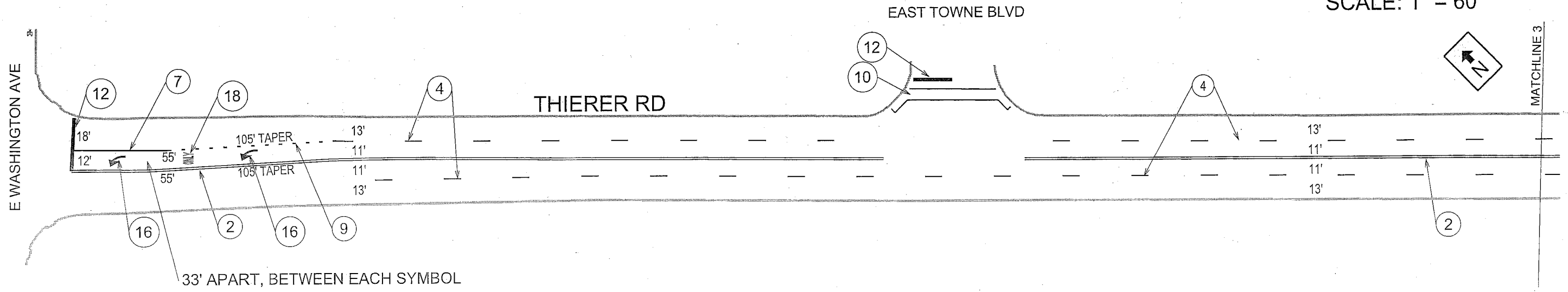

Callout	Bid Item	Description
1	60800	Pavement Marking Epoxy, 4-Inch, Solid White
2	60801	Pavement Marking Epoxy, 4-Inch Double Yellow
3	60802	Pavement Marking Epoxy, 6-Inch Solid White
4	60802	Pavement Marking Epoxy, 6-Inch White Skips, (10' Line, 30' Gap)
5	60802	Pavement Marking Epoxy, 6-Inch Yellow Skips (10' Line, 30' Gap)
6	60802	Pavement Marking Epoxy, 6-Inch White Skips, (2' Line, 6' Gap)
7	60803	Pavement Marking Epoxy, 8-Inch Solid White
8	60803	Pavement Marking Epoxy, 8-Inch White Skips, (5' Line, 5' Gap)
9	60803	Pavement Marking Epoxy, 8-Inch White Skips, (2' Line, 6' Gap)
10	60812	Pavement Marking Epoxy, 6-Inch White, Crosswalk
11	60815	Pavement Marking Epoxy, Continental Crosswalk, 18-Inch
12	60818	Pavement Marking Epoxy, 24-Inch White, Stop Line
13	60822	Pavement Marking Epoxy, Symbol, Bike Sharrow
14	60823	Pavement Marking Epoxy, Symbol, Bike Lane
15	60824	Pavement Marking Epoxy, Symbol, Bike Straight Arrow
16	60829	Pavement Marking Epoxy, Symbol, Left Arrow
17	60830	Pavement Marking Epoxy, Symbol, Right Arrow
18	60834	Pavement Marking Epoxy, Word, "ONLY"

PLOT SCALE:

PLOT NAME:

REV. DATE:

ORIGINATOR: CITY OF MADISON, TRAFFIC ENG. DIV.

Callout	Bid Item	Description
1	60800	Pavement Marking Epoxy, 4-Inch, Solid White
2	60801	Pavement Marking Epoxy, 4-Inch Double Yellow
3	60802	Pavement Marking Epoxy, 6-Inch Solid White
4	60802	Pavement Marking Epoxy, 6-Inch White Skips, (10' Line, 30' Gap)
5	60802	Pavement Marking Epoxy, 6-Inch Yellow Skips (10' Line, 30' Gap)
6	60802	Pavement Marking Epoxy, 6-Inch White Skips, (2' Line, 6' Gap)
7	60803	Pavement Marking Epoxy, 8-Inch Solid White
8	60803	Pavement Marking Epoxy, 8-Inch White Skips, (5' Line, 5' Gap)
9	60803	Pavement Marking Epoxy, 8-Inch White Skips, (2' Line, 6' Gap)
10	60812	Pavement Marking Epoxy, 6-Inch White, Crosswalk
11	60815	Pavement Marking Epoxy, Continental Crosswalk, 18-Inch
12	60818	Pavement Marking Epoxy, 24-Inch White, Stop Line
13	60822	Pavement Marking Epoxy, Symbol, Bike Sharrow
14	60823	Pavement Marking Epoxy, Symbol, Bike Lane
15	60824	Pavement Marking Epoxy, Symbol, Bike Straight Arrow
16	60829	Pavement Marking Epoxy, Symbol, Left Arrow
17	60830	Pavement Marking Epoxy, Symbol, Right Arrow
18	60834	Pavement Marking Epoxy, Word, "ONLY"
19	60831	Pavement Marking Epoxy, Symbol, Straight Arrow

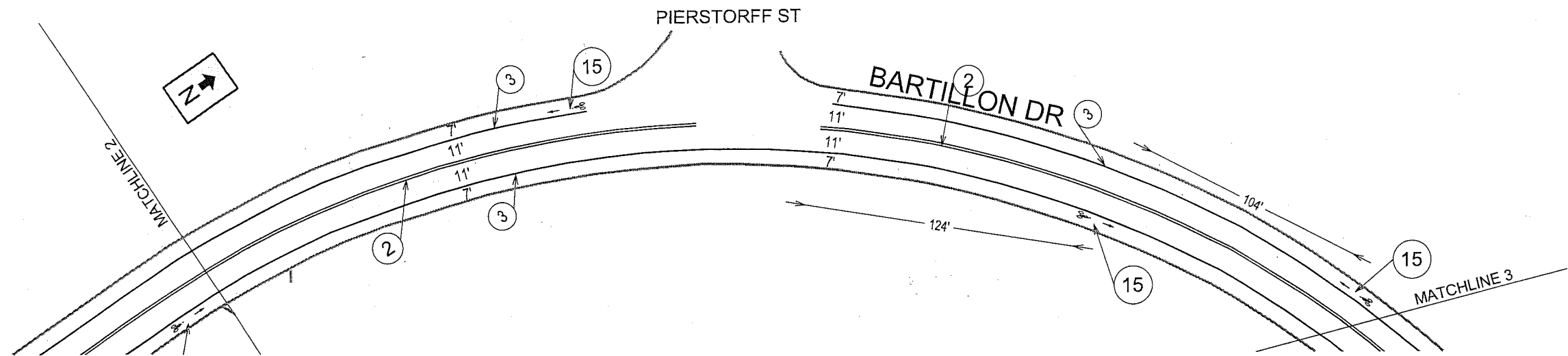
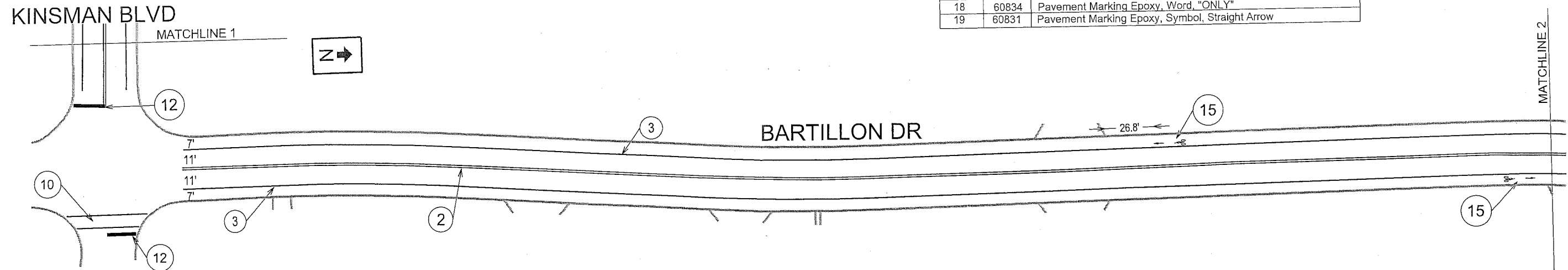
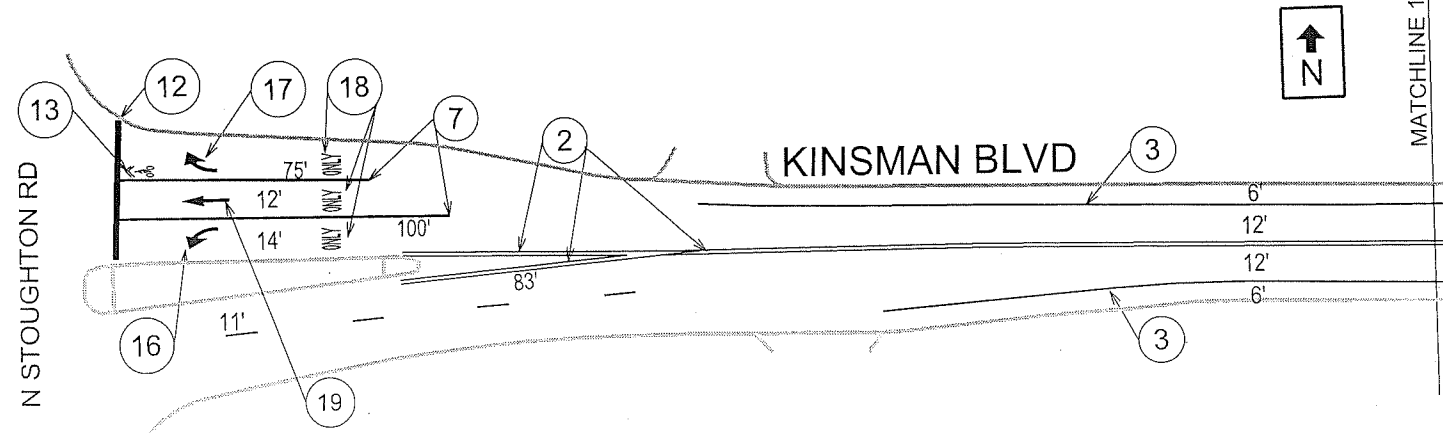

PLOT SCALE:

PLOT NAME:

REV. DATE:

ORIGINATOR: CITY OF MADISON, TRAFFIC ENG. DIV.

SCALE: 1" = 60'

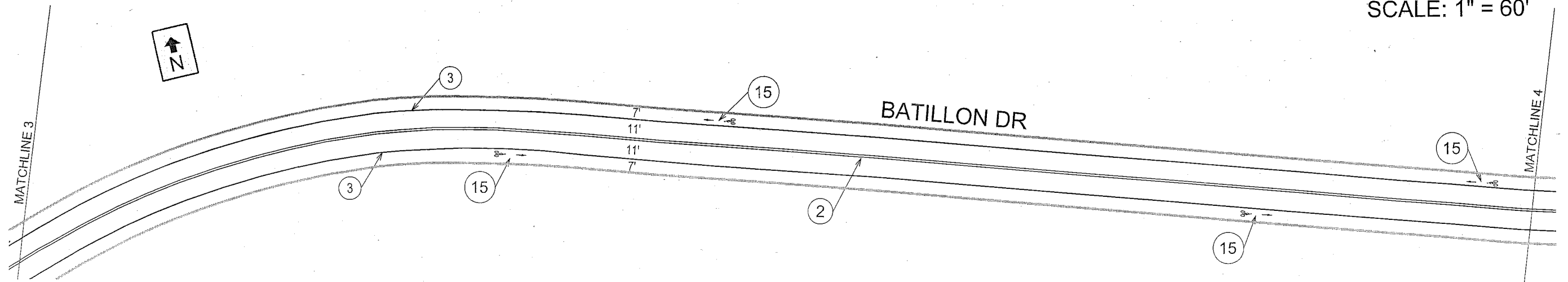

Callout	Bid Item	Description
1	60800	Pavement Marking Epoxy, 4-Inch, Solid White
2	60801	Pavement Marking Epoxy, 4-Inch Double Yellow
3	60802	Pavement Marking Epoxy, 6-Inch Solid White
4	60802	Pavement Marking Epoxy, 6-Inch White Skips, (10' Line, 30' Gap)
5	60802	Pavement Marking Epoxy, 6-Inch Yellow Skips (10' Line, 30' Gap)
6	60802	Pavement Marking Epoxy, 6-Inch White Skips, (2' Line, 6' Gap)
7	60803	Pavement Marking Epoxy, 8-Inch Solid White
8	60803	Pavement Marking Epoxy, 8-Inch White Skips, (5' Line, 5' Gap)
9	60803	Pavement Marking Epoxy, 8-Inch White Skips, (2' Line, 6' Gap)
10	60812	Pavement Marking Epoxy, 6-Inch White, Crosswalk
11	60815	Pavement Marking Epoxy, Continental Crosswalk, 18-Inch
12	60818	Pavement Marking Epoxy, 24-Inch White, Stop Line
13	60822	Pavement Marking Epoxy, Symbol, Bike Sharrow
14	60823	Pavement Marking Epoxy, Symbol, Bike Lane
15	60824	Pavement Marking Epoxy, Symbol, Bike Straight Arrow
16	60829	Pavement Marking Epoxy, Symbol, Left Arrow
17	60830	Pavement Marking Epoxy, Symbol, Right Arrow
18	60834	Pavement Marking Epoxy, Word, "ONLY"

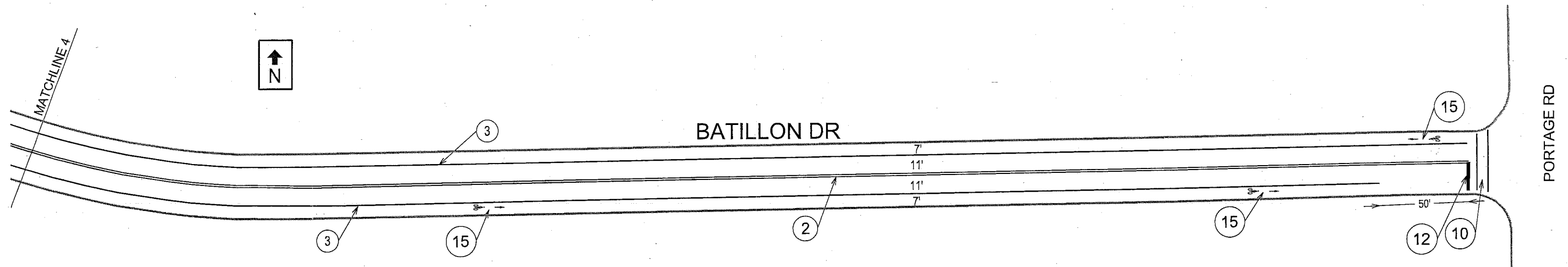

PLOT SCALE:

PLOT NAME:

REV. DATE:

ORIGINATOR: CITY OF MADISON, TRAFFIC ENG. DIV.

SCALE: 1" = 60'

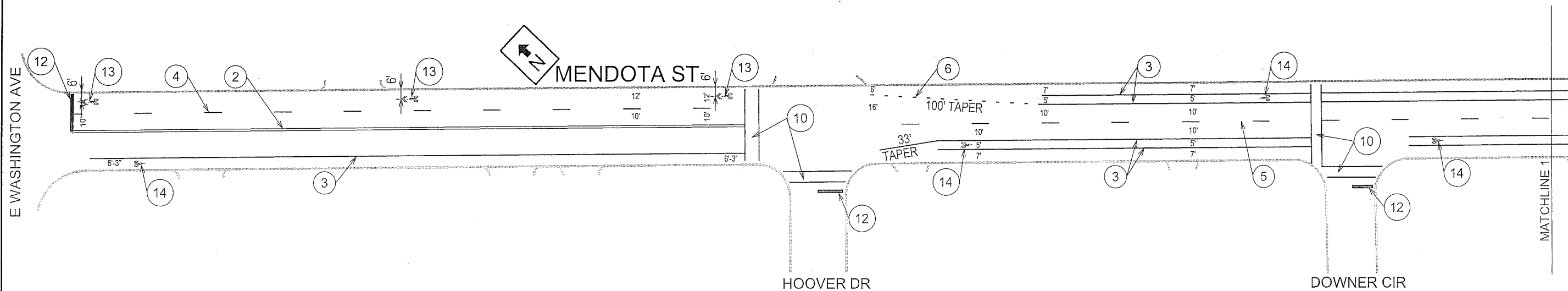

Callout	Bid Item	Description
1	60800	Pavement Marking Epoxy, 4-Inch, Solid White
2	60801	Pavement Marking Epoxy, 4-Inch Double Yellow
3	60802	Pavement Marking Epoxy, 6-Inch Solid White
4	60802	Pavement Marking Epoxy, 6-Inch White Skips, (10' Line, 30' Gap)
5	60802	Pavement Marking Epoxy, 6-Inch Yellow Skips (10' Line, 30' Gap)
6	60802	Pavement Marking Epoxy, 6-Inch White Skips, (2' Line, 6' Gap)
7	60803	Pavement Marking Epoxy, 8-Inch Solid White
8	60803	Pavement Marking Epoxy, 8-Inch White Skips, (5' Line, 5' Gap)
9	60803	Pavement Marking Epoxy, 8-Inch White Skips, (2' Line, 6' Gap)
10	60812	Pavement Marking Epoxy, 6-Inch White, Crosswalk
11	60815	Pavement Marking Epoxy, Continental Crosswalk, 18-Inch
12	60818	Pavement Marking Epoxy, 24-Inch White, Stop Line
13	60822	Pavement Marking Epoxy, Symbol, Bike Sharrow
14	60823	Pavement Marking Epoxy, Symbol, Bike Lane
15	60824	Pavement Marking Epoxy, Symbol, Bike Straight Arrow
16	60829	Pavement Marking Epoxy, Symbol, Left Arrow
17	60830	Pavement Marking Epoxy, Symbol, Right Arrow
18	60834	Pavement Marking Epoxy, Word, "ONLY"

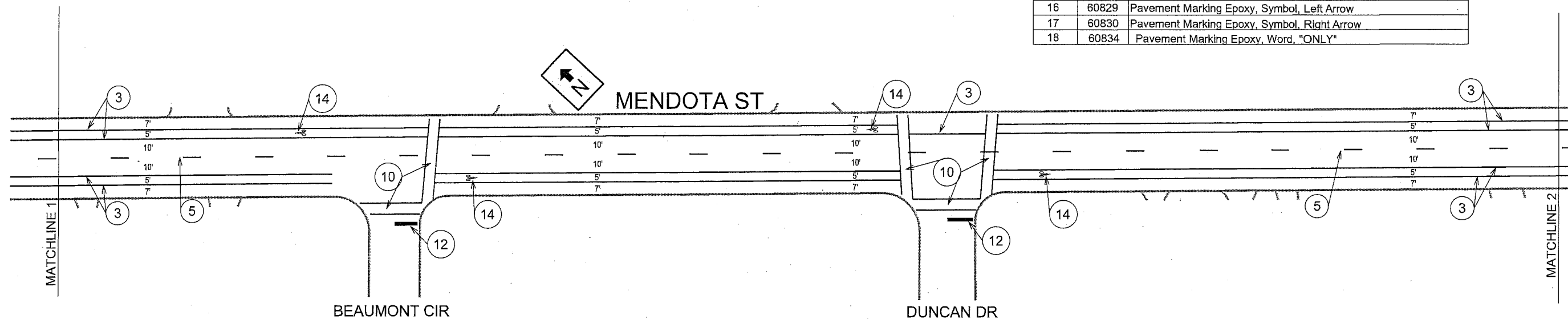

PLOT SCALE:

PLOT NAME:

REV. DATE:

ORIGINATOR: CITY OF MADISON, TRAFFIC ENG. DIV.

SCALE: 1" = 60'

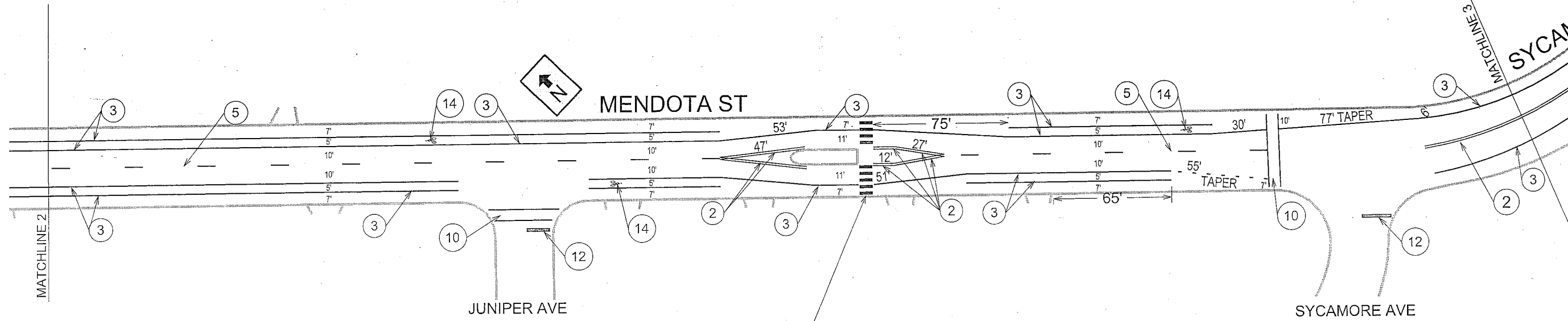

INSTALL NEW 8 FEET CONTINENTAL CROSSWALK
TE SHOP TO REMOVE OLD ZEBRA XWALK

Callout	Bid Item	Description
1	60800	Pavement Marking Epoxy, 4-Inch, Solid White
2	60801	Pavement Marking Epoxy, 4-Inch Double Yellow
3	60802	Pavement Marking Epoxy, 6-Inch Solid White
4	60802	Pavement Marking Epoxy, 6-Inch White Skips, (10' Line, 30' Gap)
5	60802	Pavement Marking Epoxy, 6-Inch Yellow Skips (10' Line, 30' Gap)
6	60802	Pavement Marking Epoxy, 6-Inch White Skips, (2' Line, 6' Gap)
7	60803	Pavement Marking Epoxy, 8-Inch Solid White
8	60803	Pavement Marking Epoxy, 8-Inch White Skips, (5' Line, 5' Gap)
9	60803	Pavement Marking Epoxy, 8-Inch White Skips, (2' Line, 6' Gap)
10	60812	Pavement Marking Epoxy, 6-Inch White, Crosswalk
11	60815	Pavement Marking Epoxy, Continental Crosswalk, 18-Inch
12	60818	Pavement Marking Epoxy, 24-Inch White, Stop Line
13	60822	Pavement Marking Epoxy, Symbol, Bike Sharrow
14	60823	Pavement Marking Epoxy, Symbol, Bike Lane
15	60824	Pavement Marking Epoxy, Symbol, Bike Straight Arrow
16	60829	Pavement Marking Epoxy, Symbol, Left Arrow
17	60830	Pavement Marking Epoxy, Symbol, Right Arrow
18	60834	Pavement Marking Epoxy, Word, "ONLY"

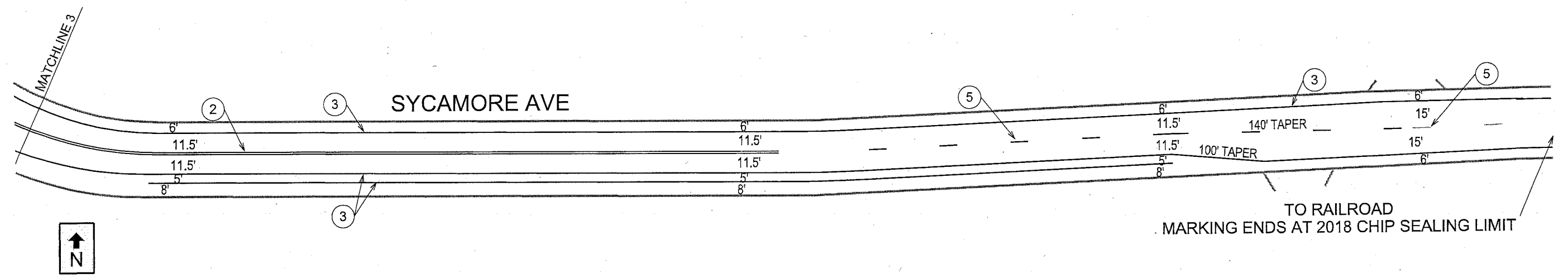

PLOT SCALE:
PLOT NAME:
REV. DATE:
ORIGINATOR: CITY OF MADISON, TRAFFIC ENG. DIV.

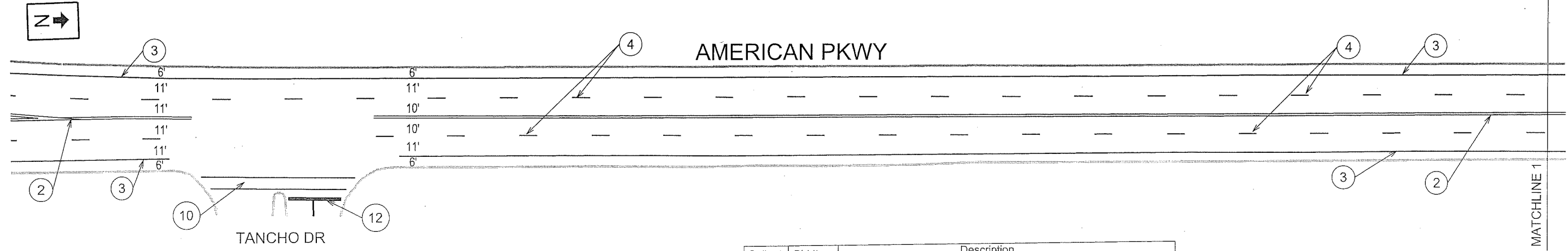

Callout	Bid Item	Description
1	60800	Pavement Marking Epoxy, 4-Inch, Solid White
2	60801	Pavement Marking Epoxy, 4-Inch Double Yellow
3	60802	Pavement Marking Epoxy, 6-Inch Solid White
4	60802	Pavement Marking Epoxy, 6-Inch White Skips, (10' Line, 30' Gap)
5	60802	Pavement Marking Epoxy, 6-Inch Yellow Skips (10' Line, 30' Gap)
6	60802	Pavement Marking Epoxy, 6-Inch White Skips, (2' Line, 6' Gap)
7	60803	Pavement Marking Epoxy, 8-Inch Solid White
8	60803	Pavement Marking Epoxy, 8-Inch White Skips, (5' Line, 5' Gap)
9	60803	Pavement Marking Epoxy, 8-Inch White Skips, (2' Line, 6' Gap)
10	60812	Pavement Marking Epoxy, 6-Inch White, Crosswalk
11	60815	Pavement Marking Epoxy, Continental Crosswalk, 18-Inch
12	60818	Pavement Marking Epoxy, 24-Inch White, Stop Line
13	60822	Pavement Marking Epoxy, Symbol, Bike Sharrow
14	60823	Pavement Marking Epoxy, Symbol, Bike Lane
15	60824	Pavement Marking Epoxy, Symbol, Bike Straight Arrow
16	60829	Pavement Marking Epoxy, Symbol, Left Arrow
17	60830	Pavement Marking Epoxy, Symbol, Right Arrow
18	60834	Pavement Marking Epoxy, Word, "ONLY"

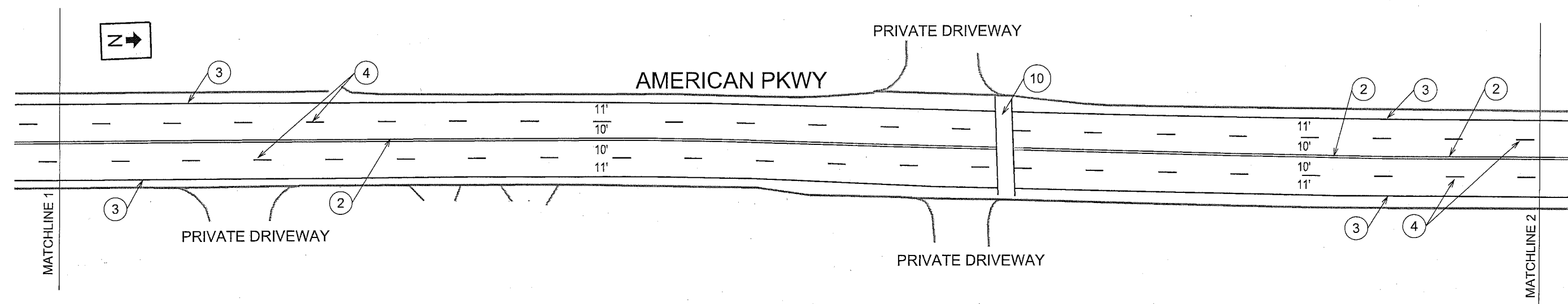

PLOT SCALE:

PLOT NAME:

REV. DATE:

ORIGINATOR: CITY OF MADISON, TRAFFIC ENG. DIV.

SCALE: 1" = 60'

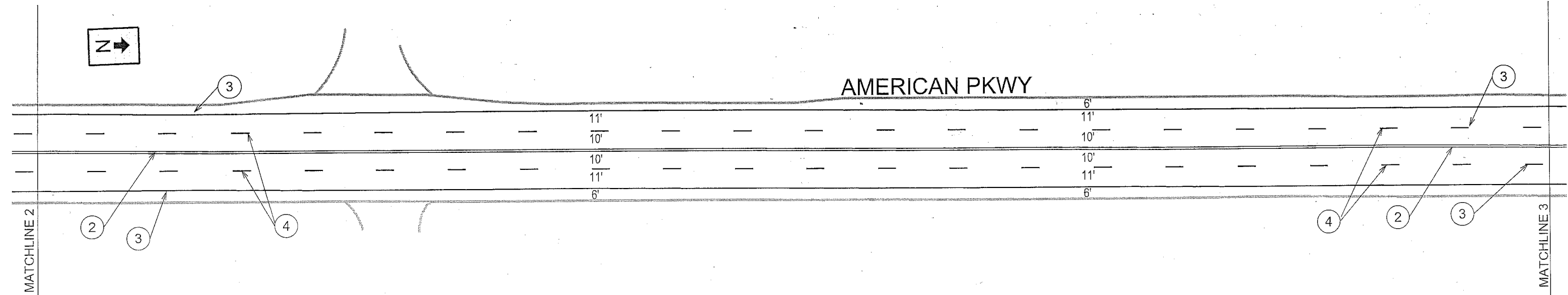

Callout	Bid Item	Description
1	60800	Pavement Marking Epoxy, 4-Inch, Solid White
2	60801	Pavement Marking Epoxy, 4-Inch Double Yellow
3	60802	Pavement Marking Epoxy, 6-Inch Solid White
4	60802	Pavement Marking Epoxy, 6-Inch White Skips, (10' Line, 30' Gap)
5	60802	Pavement Marking Epoxy, 6-Inch Yellow Skips (10' Line, 30' Gap)
6	60802	Pavement Marking Epoxy, 6-Inch White Skips, (2' Line, 6' Gap)
7	60803	Pavement Marking Epoxy, 8-Inch Solid White
8	60803	Pavement Marking Epoxy, 8-Inch White Skips, (5' Line, 5' Gap)
9	60803	Pavement Marking Epoxy, 8-Inch White Skips, (2' Line, 6' Gap)
10	60812	Pavement Marking Epoxy, 6-Inch White, Crosswalk
11	60815	Pavement Marking Epoxy, Continental Crosswalk, 18-Inch
12	60818	Pavement Marking Epoxy, 24-Inch White, Stop Line
13	60822	Pavement Marking Epoxy, Symbol, Bike Sharrow
14	60823	Pavement Marking Epoxy, Symbol, Bike Lane
15	60824	Pavement Marking Epoxy, Symbol, Bike Straight Arrow
16	60829	Pavement Marking Epoxy, Symbol, Left Arrow
17	60830	Pavement Marking Epoxy, Symbol, Right Arrow
18	60834	Pavement Marking Epoxy, Word, "ONLY"

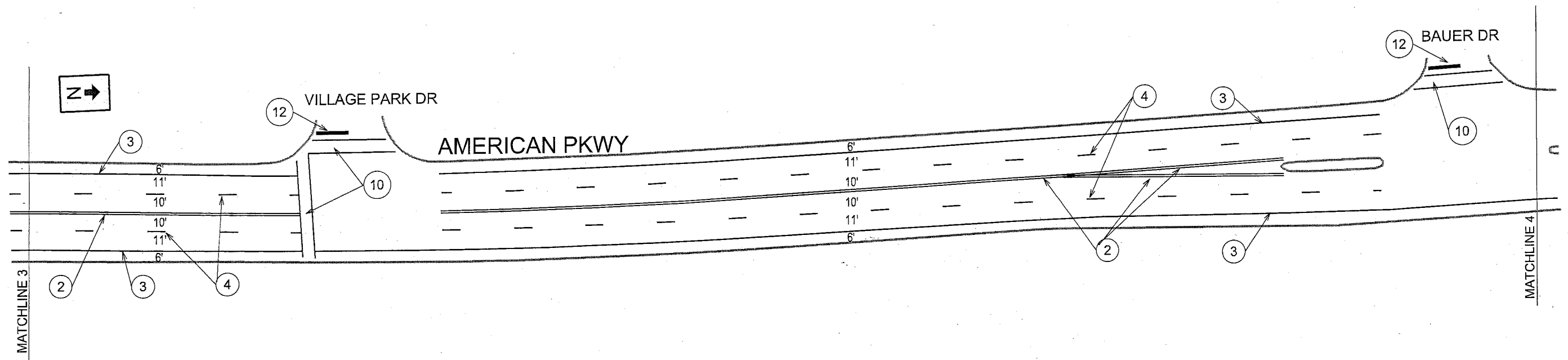

PLOT SCALE:

PLOT NAME:

REV. DATE:

ORIGINATOR: CITY OF MADISON, TRAFFIC ENG. DIV.

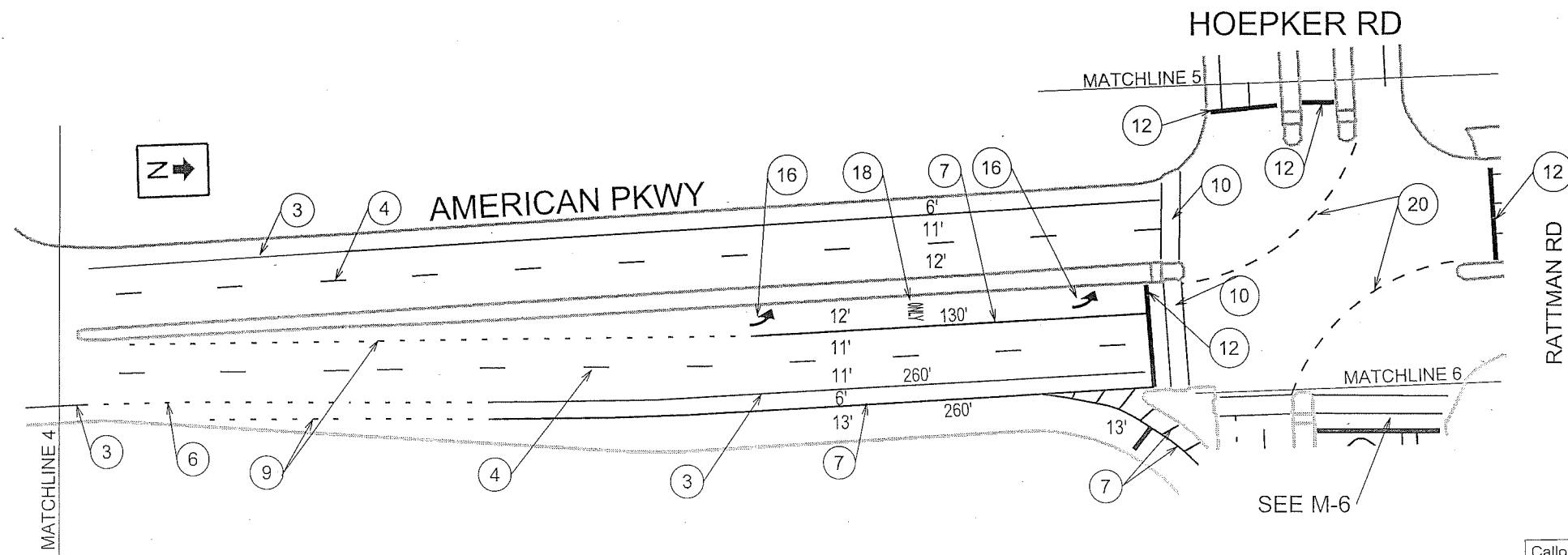

Callout	Bid Item	Description
1	60800	Pavement Marking Epoxy, 4-Inch, Solid White
2	60801	Pavement Marking Epoxy, 4-Inch Double Yellow
3	60802	Pavement Marking Epoxy, 6-Inch Solid White
4	60802	Pavement Marking Epoxy, 6-Inch White Skips, (10' Line, 30' Gap)
5	60802	Pavement Marking Epoxy, 6-Inch Yellow Skips (10' Line, 30' Gap)
6	60802	Pavement Marking Epoxy, 6-Inch White Skips, (2' Line, 6' Gap)
7	60803	Pavement Marking Epoxy, 8-Inch Solid White
8	60803	Pavement Marking Epoxy, 8-Inch White Skips, (5' Line, 5' Gap)
9	60803	Pavement Marking Epoxy, 8-Inch White Skips, (2' Line, 6' Gap)
10	60812	Pavement Marking Epoxy, 6-Inch White, Crosswalk
11	60815	Pavement Marking Epoxy, Continental Crosswalk, 18-Inch
12	60818	Pavement Marking Epoxy, 24-Inch White, Stop Line
13	60822	Pavement Marking Epoxy, Symbol, Bike Sharrow
14	60823	Pavement Marking Epoxy, Symbol, Bike Lane
15	60824	Pavement Marking Epoxy, Symbol, Bike Straight Arrow
16	60829	Pavement Marking Epoxy, Symbol, Left Arrow
17	60830	Pavement Marking Epoxy, Symbol, Right Arrow
18	60834	Pavement Marking Epoxy, Word, "ONLY"
19	60831	Pavement Marking Epoxy, Symbol, Straight Arrow
20	60806	Pavement Marking Epoxy, Radius Line, (5' Line x 5' Gap)

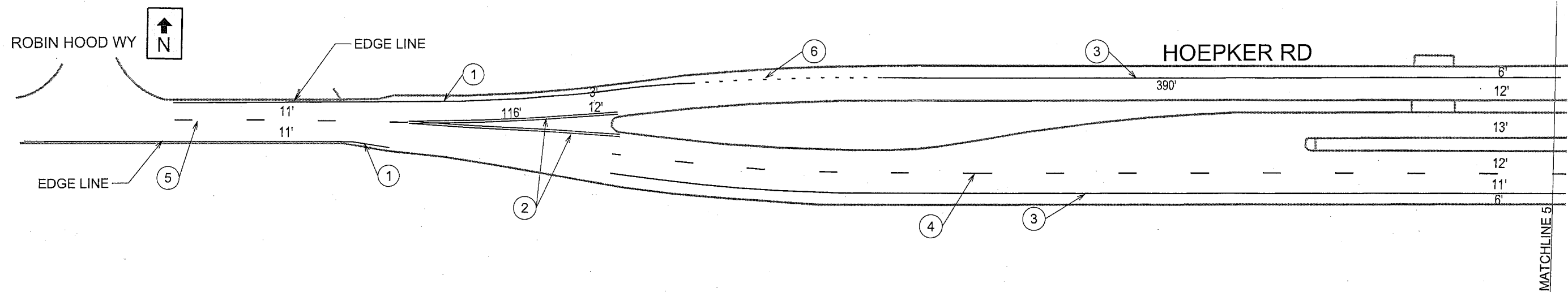

PLOT SCALE:

PLOT NAME:

REV. DATE:

ORIGINATOR: CITY OF MADISON, TRAFFIC ENG. DIV.

PLOT SCALE:

PLOT NAME:

REV. DATE:

ORIGINATOR: CITY OF MADISON, TRAFFIC ENG. DIV.

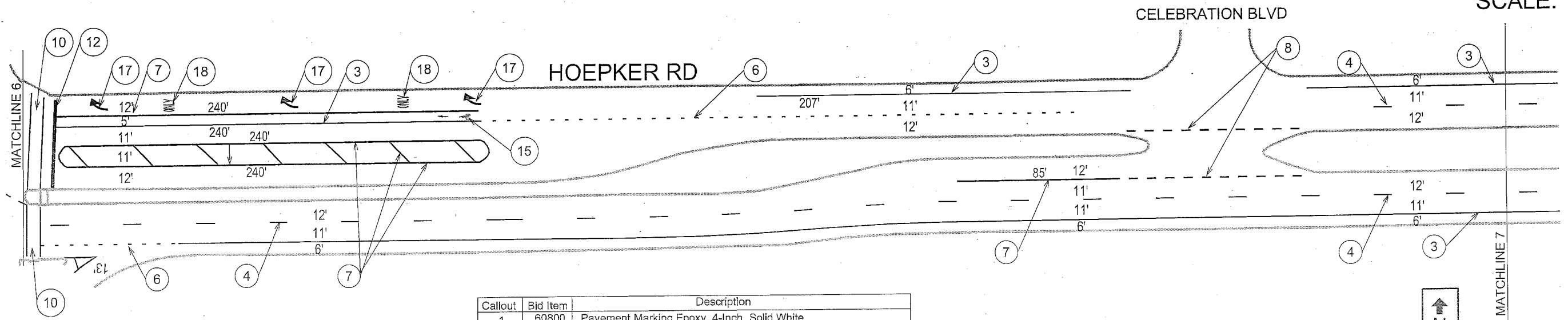

Callout	Bid Item	Description
1	60800	Pavement Marking Epoxy, 4-Inch, Solid White
2	60801	Pavement Marking Epoxy, 4-Inch Double Yellow
3	60802	Pavement Marking Epoxy, 6-Inch Solid White
4	60802	Pavement Marking Epoxy, 6-Inch White Skips, (10' Line, 30' Gap)
5	60802	Pavement Marking Epoxy, 6-Inch Yellow Skips (10' Line, 30' Gap)
6	60802	Pavement Marking Epoxy, 6-Inch White Skips, (2' Line, 6' Gap)
7	60803	Pavement Marking Epoxy, 8-Inch Solid White
8	60803	Pavement Marking Epoxy, 8-Inch White Skips, (5' Line, 5' Gap)
9	60803	Pavement Marking Epoxy, 8-Inch White Skips, (2' Line, 6' Gap)
10	60812	Pavement Marking Epoxy, 6-Inch White, Crosswalk
11	60815	Pavement Marking Epoxy, Continental Crosswalk, 18-Inch
12	60818	Pavement Marking Epoxy, 24-Inch White, Stop Line
13	60822	Pavement Marking Epoxy, Symbol, Bike Sharrow
14	60823	Pavement Marking Epoxy, Symbol, Bike Lane
15	60824	Pavement Marking Epoxy, Symbol, Bike Straight Arrow
16	60829	Pavement Marking Epoxy, Symbol, Left Arrow
17	60830	Pavement Marking Epoxy, Symbol, Right Arrow
18	60834	Pavement Marking Epoxy, Word, "ONLY"

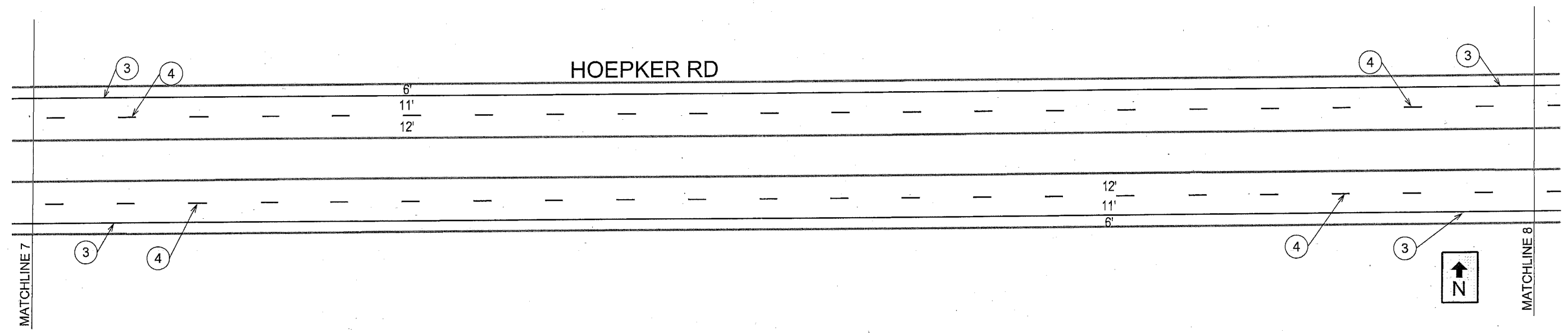

SCALE: 1" = 60'

Callout	Bid Item	Description
1	60800	Pavement Marking Epoxy, 4-Inch, Solid White
2	60801	Pavement Marking Epoxy, 4-Inch Double Yellow
3	60802	Pavement Marking Epoxy, 6-Inch Solid White
4	60802	Pavement Marking Epoxy, 6-Inch White Skips, (10' Line, 30' Gap)
5	60802	Pavement Marking Epoxy, 6-Inch Yellow Skips (10' Line, 30' Gap)
6	60802	Pavement Marking Epoxy, 6-Inch White Skips, (2' Line, 6' Gap)
7	60803	Pavement Marking Epoxy, 8-Inch Solid White
8	60803	Pavement Marking Epoxy, 8-Inch White Skips, (5' Line, 5' Gap)
9	60803	Pavement Marking Epoxy, 8-Inch White Skips, (2' Line, 6' Gap)
10	60812	Pavement Marking Epoxy, 6-Inch White, Crosswalk
11	60815	Pavement Marking Epoxy, Continental Crosswalk, 18-Inch
12	60818	Pavement Marking Epoxy, 24-Inch White, Stop Line
13	60822	Pavement Marking Epoxy, Symbol, Bike Sharrow
14	60823	Pavement Marking Epoxy, Symbol, Bike Lane
15	60824	Pavement Marking Epoxy, Symbol, Bike Straight Arrow
16	60829	Pavement Marking Epoxy, Symbol, Left Arrow
17	60830	Pavement Marking Epoxy, Symbol, Right Arrow
18	60834	Pavement Marking Epoxy, Word, "ONLY"

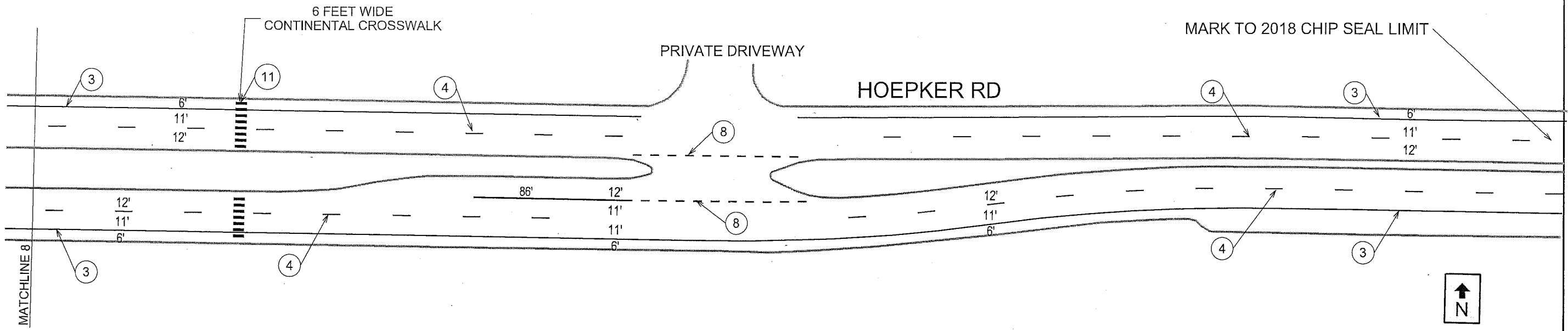

PLOT SCALE:

PLOT NAME:

REV. DATE:

ORIGINATOR: CITY OF MADISON, TRAFFIC ENG. DIV.



Madison Police Department
Parking Enforcement
Phone: (608) 266-4622
www.cityofmadison.com/police



City of Madison Parking Utility
215 Martin Luther King Blvd, Suite 100
Madison, WI 53703
Phone: (608) 266-4761
www.cityofmadison.com/parking

Posting for Temporary Parking Restrictions

Instructions

1. Partial & full block postings: signs every 50-60 feet.
Single address postings: signs at the boundaries of your property.
2. Signs **must** be 3-4 feet off the ground, facing oncoming traffic, and perpendicular to the street.
3. Signs should be placed within 3 feet of the curb.
4. **Call (608) 266-4622** (Monday - Friday before 3pm) for signs to be checked.
Signs must be approved 48 hours in advance before enforcement can be taken.
5. Changes to your No Parking signs (dates) **must be updated through Parking Utility** and the signs will need to be rechecked.
6. You are responsible for removing your temporary posting signs and uncovering any signs that were covered.

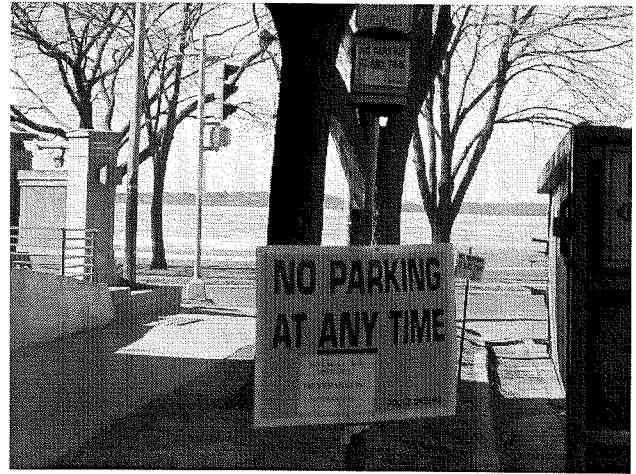

Things to Remember

1. Signs may not be attached to trees or electrical poles & cannot be blocked by trees, bushes, poles, etc.
2. **Signs must be securely fastened** to the stake & secure in the ground.

Who to Call for Enforcement

If a vehicle is parked in your approved posted area, **contact dispatch at (608) 266-4275.**



SECTION E: BIDDERS ACKNOWLEDGEMENT

CHIP SEALING 2018 - EAST
CONTRACT NO. 8093

Bidder must state a Unit Price and Total Bid for each item. The Total Bid for each item must be the product of quantity, by Unit Price. The Grand Total must be the sum of the Total Bids for the various items. In case of multiplication errors or addition errors, the Grand Total with corrected multiplication and/or addition shall determine the Grand Total bid for each contract. The Unit Price and Total Bid must be entered numerically in the spaces provided. All words and numbers shall be written in ink.

1. The undersigned having familiarized himself/herself with the Contract documents, including Advertisement for Bids, Instructions to Bidders, Form of Proposal, City of Madison Standard Specifications for Public Works Construction - 2018 Edition thereto, Form of Agreement, Form of Bond, and Addenda issued and attached to the plans and specifications on file in the office of the City Engineer, hereby proposes to provide and furnish all the labor, materials, tools, and expendable equipment necessary to perform and complete in a workmanlike manner the specified construction on this project for the City of Madison; all in accordance with the plans and specifications as prepared by the City Engineer, including Addenda Nos. _____ through _____ to the Contract, at the prices for said work as contained in this proposal. (Electronic bids submittals shall acknowledge addendum under Section E and shall not acknowledge here)
2. If awarded the Contract, we will initiate action within seven (7) days after notification or in accordance with the date specified in the contract to begin work and will proceed with diligence to bring the project to full completion within the number of work days allowed in the Contract or by the calendar date stated in the Contract.
3. The undersigned Bidder or Contractor certifies that he/she is not a party to any contract, combination in form of trust or otherwise, or conspiracy in restraint of trade or commerce or any other violation of the anti-trust laws of the State of Wisconsin or of the United States, with respect to this bid or contract or otherwise.
4. I hereby certify that I have met the Bid Bond Requirements as specified in Section 102.5. (IF BID BOND IS USED, IT SHALL BE SUBMITTED ON THE FORMS PROVIDED BY THE CITY. FAILURE TO DO SO MAY RESULT IN REJECTION OF THE BID).
5. I hereby certify that all statements herein are made on behalf of Fabner Asphalt Sealers, LLC (name of corporation, partnership, or person submitting bid) a corporation organized and existing under the laws of the State of Wisconsin a partnership consisting of _____; an individual trading as _____ of the City of _____ State of _____; that I have examined and carefully prepared this Proposal, from the plans and specifications and have checked the same in detail before submitting this Proposal; that I have fully authority to make such statements and submit this Proposal in (its, their) behalf; and that the said statements are true and correct.

 SIGNATURE Jim Rozumialski
Vice President - Waunakee
 TITLE, IF ANY

Sworn and subscribed to before me this
12 day of April, 2018

(Notary Public or other officer authorized to administer oaths)
 My Commission Expires 5/15/2020

Bidders shall not add any conditions or qualifying statements to this Proposal.

Contract 8093 – Fahrner Asphalt Sealers, L.L.C.

Section F: Best Value Contracting (BVC)

This section is a required document for the bid to be considered complete. There are two methods for completing the Best Value Contracting (BVC) form. Method one: The form can be filled out online and submitted to this site to be included with your electronic bid. Method two: The form can be downloaded from the site and submitted by hand to the City of Madison.

Method of Submittal for BVC (click in box below to choose) *

I will submit Bid Express fillable online form (BVC).

Best Value Contracting

1. The Contractor shall indicate the non-apprenticeable trades used on this contract.

Chip sealing general laborers

2. Madison General Ordinance (M.G.O.), 33.07(7), does provide for some exemptions from the active apprentice requirement. Apprenticeable trades are those trades considered apprenticeable by the State of Wisconsin. Please check applicable box if you are seeking an exemption.

- Contractor has a total skilled workforce of four or less individuals in all apprenticeable trades combined.
- No available trade training program; The Contractor has been rejected by the only available trade training program, or there is no trade training program within 90 miles.
- Contractor is not using an apprentice due to having a journey worker on layoff status, provided the journey worker was employed by the contractor in the past six months.
- First time contractor on City of Madison Public Works contract requests a onetime exemption but intends to comply on all future contracts and is taking steps typical of a "good faith" effort.
- Contractor has been in business less than one year.
- Contractor doesn't have enough journeyman trade workers to qualify for a trade training program in that respective trade.
- An exemption is granted in accordance with a time period of a "Documented Depression" as defined by the State of Wisconsin.

3. The Contractor shall indicate on the following section which apprenticeable trades are to be used on this contract. Compliance with active apprenticeship, to the extent required by M.G.O. 33.07(7), shall be satisfied by documentation from an applicable trade training body; an apprenticeship contract with the Wisconsin Department of Workforce Development or a similar agency in another state; or the U.S Department of Labor. This documentation is required prior to the Contractor beginning work on the project site.

The Contractor has reviewed the list and shall not use any apprenticeable trades on this project.

LIST APPRENTICABLE TRADES (check all that apply to your work to be performed on this contract)

- BRICKLAYER
- CARPENTER
- CEMENT MASON / CONCRETE FINISHER
- CEMENT MASON (HEAVY HIGHWAY)
- CONSTRUCTION CRAFT LABORER
- DATA COMMUNICATION INSTALLER
- ELECTRICIAN
- ENVIRONMENTAL SYSTEMS TECHNICIAN / HVAC SERVICE TECH/HVAC INSTALL / SERVICE
- GLAZIER
- HEAVY EQUIPMENT OPERATOR / OPERATING ENGINEER
- INSULATION WORKER (HEAT and FROST)
- IRON WORKER
- IRON WORKER (ASSEMBLER, METAL BLDGS)
- PAINTER and DECORATOR
- PLASTERER
- PLUMBER
- RESIDENTIAL ELECTRICIAN
- ROOFER and WATER PROOFER
- SHEET METAL WORKER
- SPRINKLER FITTER
- STEAMFITTER
- STEAMFITTER (REFRIGERATION)
- STEAMFITTER (SERVICE)
- TAPER and FINISHER
- TELECOMMUNICATIONS (VOICE, DATA and VIDEO) INSTALLER-TECHNICIAN
- TILE SETTER

CHIP SEALING 2018 - EAST
CONTRACT NO. 8093

Small Business Enterprise Compliance Report

This information may be submitted electronically through
Bid Express or submitted with bid in sealed envelope.

Cover Sheet

Prime Bidder Information

Company: Fahrner Asphalt Sealers, LLC
Address: 3116 Raemisch Rd. Wauwaukee, WI 53597
Telephone Number: 608-849-6466 Fax Number: 608-849-6470
Contact Person/Title: Jim Rozumialski / Vice President - Wauwaukee

Prime Bidder Certification

I, Jim Rozumialski Vice President - Wauwaukee of
Name Title
Fahrner Asphalt Sealers, LLC certify that the information
Company

contained in this SBE Compliance Report is true and correct to the best of my knowledge and belief.

[Signature]
Witness' Signature

[Signature]
Bidder's Signature

April 12, 2018
Date

**CHIP SEALING 2018 - EAST
CONTRACT NO. 8093**

Small Business Enterprise Compliance Report

Summary Sheet

SBE Subcontractors Who Are NOT Suppliers

Name(s) of SBEs Utilized	Type of Work	% of Total Bid Amount
		%
Stratton Trucking	Dumptruck	3 %
		%
		%
		%
		%
		%
		%
		%
		%
		%
		%
		%
		%
		%
		%
		%
		%
		%
		%
		%
Subtotal SBE who are NOT suppliers:		<u>3</u> %

SBE Subcontractors Who Are Suppliers

Name(s) of SBEs Utilized	Type of Work	% of Total Bid Amount
		%
		%
		%
		%
		%
		%
		%
		%
		%
		%
Subtotal Contractors who are suppliers:		_____ % x 0.6 = _____ % (discounted to 60%)
Total Percentage of SBE Utilization:		<u>3</u> %

CHIP SEALING 2018 - EAST

CONTRACT NO. 8093

DATE: 4/12/18

**Fahrner Asphalt Sealers,
L.L.C.**

Item	Quantity	Price	Extension
Section B: Proposal Page			
1 - AMERICAN FAMILY DR-TANCHO DR-EASTPARK BLVD - LUMP SUM	1.00	\$14,205.00	\$14,205.00
2 - *AMERICAN PKWY-767 FT N OF AMERICAN FAMILY DR-HOEPKER RD - LUMP SUM	1.00	\$38,892.00	\$38,892.00
3 - *ANNAMARK DR-E WASHINGTON AVE OFF-RAMP-HIGH CROSSING BLVD - LUMP SUM	1.00	\$11,220.00	\$11,220.00
4 - ANNIVERSARY CT-ANNIVERSARY LN-262 FT S OF ANNIVERSARY LN - LUMP SUM	1.00	\$1,663.00	\$1,663.00
5 - ANNIVERSARY LN-INDEPENDENCE LN-HAYES RD - LUMP SUM	1.00	\$14,190.00	\$14,190.00
6 - ARMISTICE LN-INDEPENDENCE LN-VICTORIA LN - LUMP SUM	1.00	\$6,507.00	\$6,507.00
7 - ARTISAN DR-SYCAMORE AVE-N THOMPSON DR - LUMP SUM	1.00	\$5,759.00	\$5,759.00
8 - *BARTILLON DR-ORIN RD-PORTAGE RD - LUMP SUM	1.00	\$25,403.00	\$25,403.00
9 - BASIL CT-OLD GATE RD-250 FT SE OF OLD GATE RD - LUMP SUM	1.00	\$1,700.00	\$1,700.00
10 - BASIL DR-OLD GATE RD-CLOVE DR - LUMP SUM	1.00	\$8,441.00	\$8,441.00
11 - BAUER DR-W END-AMERICAN PKWY - LUMP SUM	1.00	\$6,204.00	\$6,204.00
12 - BEAUMONT CIR-MENDOTA ST-W END - LUMP SUM	1.00	\$1,180.00	\$1,180.00
13 - BELLGROVE LN-SUTTERIDGE TRL-DI LORETO AVE - LUMP SUM	1.00	\$7,161.00	\$7,161.00
14 - BIRCHWOOD CIR-N THOMPSON DR-194 FT SW OF N THOMPSON DR - LUMP SUM	1.00	\$1,256.00	\$1,256.00
15 - BLUESTEM WAY-MESTA LN-WINTERGREEN DR - LUMP SUM	1.00	\$3,584.00	\$3,584.00
16 - BULTMAN RD-GOLDEN LEAF TRL-199 FT N OF BUTTERFIELD DR - LUMP SUM	1.00	\$14,706.00	\$14,706.00
17 - BUNKER HILL LN-INDEPENDENCE LN-VICTORIA LN - LUMP SUM	1.00	\$5,313.00	\$5,313.00
18 - BURKE RD-CITY VIEW DR-1018 FT E OF CONGRESS AVE - LUMP SUM	1.00	\$8,385.00	\$8,385.00
19 - BUTTERFIELD DR-BULTMAN RD-SUMMER RIDGE DR - LUMP SUM	1.00	\$3,424.00	\$3,424.00
20 - BUTTONWOOD CT-BUTTONWOOD DR-699 FT N OF BUTTONWOOD DR - LUMP SUM	1.00	\$3,798.00	\$3,798.00
21 - *BUTTONWOOD DR-AMERICAN PKWY-S BILTMORE LN - LUMP SUM	1.00	\$7,854.00	\$7,854.00
22 - CARBERRY ST-BELLGROVE LN-148 FT N OF DI LORETO AVE - LUMP SUM	1.00	\$4,815.00	\$4,815.00
23 - CELEBRATION PKWY-FIELDWOOD RD-VILLAGE PARK DR - LUMP SUM	1.00	\$4,877.00	\$4,877.00
24 - CHIVE CT-CLOVE DR-E END - LUMP SUM	1.00	\$1,808.00	\$1,808.00
25 - *CITY VIEW DR-250 FT NE OF CROSSROADS DR-HIGH CROSSING BLVD - LUMP SUM	1.00	\$25,593.00	\$25,593.00
26 - CLARENDON CT-GREEN RIDGE DR-E END - LUMP SUM	1.00	\$2,508.00	\$2,508.00
27 - CLOVE DR-PORTAGE RD-BASIL DR - LUMP SUM	1.00	\$14,302.00	\$14,302.00
28 - CONGRESS AVE-665 FT N OF BURKE RD-CROSS HILL DR - LUMP SUM	1.00	\$9,562.00	\$9,562.00
29 - COTTONWOOD CIR-N THOMPSON DR-197 FT E OF N THOMPSON DR - LUMP SUM	1.00	\$1,257.00	\$1,257.00

CHIP SEALING 2018 - EAST
 CONTRACT NO. 8093
 DATE: 4/12/18

Fahrner Asphalt Sealers,
 L.L.C.

Item	Quantity	Price	Extension
30 - CRESCENT OAKS CT-CRESCENT OAKS DR-115 FT SE OF CRESCENT OAKS DR - LUMP SUM	1.00	\$1,238.00	\$1,238.00
31 - CRESCENT OAKS DR-N THOMPSON DR-ESKER DR - LUMP SUM	1.00	\$6,369.00	\$6,369.00
32 - CREST LINE DR-S END-DAVID RD - LUMP SUM	1.00	\$10,011.00	\$10,011.00
33 - CROSS HILL DR-315 FT E OF CONGRESS AVE-HIGH CROSSING BLVD - LUMP SUM	1.00	\$5,524.00	\$5,524.00
34 - CROSSING PL-NELSON RD-GRAND CROSSING RD - LUMP SUM	1.00	\$5,244.00	\$5,244.00
35 - *CROSSROADS DR-728 FT S OF WALL ST-HIGH CROSSING BLVD - LUMP SUM	1.00	\$18,975.00	\$18,975.00
36 - DAVID RD-W END-455 FT E OF CREST LINE DR - LUMP SUM	1.00	\$4,107.00	\$4,107.00
37 - DECLARATION LN-INDEPENDENCE LN-BUNKER HILL LN - LUMP SUM	1.00	\$5,445.00	\$5,445.00
38 - DEREK RD-PORTAGE RD-E END - LUMP SUM	1.00	\$6,006.00	\$6,006.00
39 - DI LORETO AVE-VIDON DR-PORTAGE RD - LUMP SUM	1.00	\$6,907.00	\$6,907.00
40 - DOWNER CIR-MENDOTA ST-172 FT SW OF MENDOTA ST - LUMP SUM	1.00	\$11,088.00	\$11,088.00
41 - DUKE ST-PORTAGE RD-DWIGHT DR - LUMP SUM	1.00	\$3,142.00	\$3,142.00
42 - DUNCAN DR-ELLENWOOD DR-MENDOTA ST - LUMP SUM	1.00	\$2,214.00	\$2,214.00
43 - DWIGHT DR-HAGAN DR-INDEPENDENCE LN - LUMP SUM	1.00	\$9,855.00	\$9,855.00
44 - EAGLE CREST DR-COMMERCIAL AVE-GOLDEN LEAF TRL - LUMP SUM	1.00	\$11,055.00	\$11,055.00
45 - *EAST TERRACE DR-EASTPARK BLVD-WEST TERRACE DR - LUMP SUM	1.00	\$16,866.00	\$16,866.00
46 - *EAST TOWNE BLVD-THIERER RD-ZEIER RD - LUMP SUM	1.00	\$25,427.00	\$25,427.00
47 - EASTPARK BLVD-EASTPARK CT-AMERICAN FAMILY DR - LUMP SUM	1.00	\$11,270.00	\$11,270.00
48 - EASTPARK CT-EASTPARK BLVD-358 FT S OF EASTPARK BLVD - LUMP SUM	1.00	\$2,412.00	\$2,412.00
49 - ELLENWOOD DR-DUNCAN DR-HOOVER DR - LUMP SUM	1.00	\$4,671.00	\$4,671.00
50 - ESKER DR-N THOMPSON DR-GLACIER HILL DR - LUMP SUM	1.00	\$9,747.00	\$9,747.00
51 - FELLAND RD-NELSON RD-CROSSING PL - LUMP SUM	1.00	\$9,174.00	\$9,174.00
52 - FIELDWOOD RD-TREE RIDGE TRL-HOEPKER RD - LUMP SUM	1.00	\$6,089.00	\$6,089.00
53 - FOREST DALE CT-CREST LINE DR-N END - LUMP SUM	1.00	\$1,399.00	\$1,399.00
54 - GERALD ST-DONALD DR-TOMSCOT TRL - LUMP SUM	1.00	\$4,364.00	\$4,364.00
55 - GLACIER HILL DR-GOLDEN LEAF TRL-LIEN RD - LUMP SUM	1.00	\$20,915.00	\$20,915.00
56 - GOLDEN LEAF TRL-N THOMPSON DR-HAZELCREST DR - LUMP SUM	1.00	\$12,834.00	\$12,834.00
57 - GRANBY CIR-OLD GATE RD-256 FT S OF OLD GATE RD - LUMP SUM	1.00	\$1,568.00	\$1,568.00
58 - GRAND CROSSING RD-CROSSING PL-MORGAN WAY - LUMP SUM	1.00	\$2,917.00	\$2,917.00
59 - GRAYHAWK TRL-145 FT N OF DI LORETO AVE-BELMGROVE LN - LUMP SUM	1.00	\$4,800.00	\$4,800.00
60 - GREEN RIDGE CT-GREEN RIDGE DR-E END - LUMP SUM	1.00	\$1,506.00	\$1,506.00
61 - GREEN RIDGE DR-MELODY LN-DEREK RD - LUMP SUM	1.00	\$6,159.00	\$6,159.00
62 - HAGAN DR-E WASHINGTON AVE-DWIGHT DR - LUMP SUM	1.00	\$2,181.00	\$2,181.00
63 - *HAYES RD-BELMGROVE LN-ANNIVERSARY LN - LUMP SUM	1.00	\$27,741.00	\$27,741.00

CHIP SEALING 2018 - EAST

CONTRACT NO. 8093

DATE: 4/12/18

**Fahrner Asphalt Sealers,
L.L.C.**

Item	Quantity	Price	Extension
64 - HAZELCREST DR-N THOMPSON DR-TONY DR - LUMP SUM	1.00	\$13,101.00	\$13,101.00
65 - *HOEPKER RD-ROBIN HOOD WAY-CELEBRATION BLVD - LUMP SUM	1.00	\$17,528.00	\$17,528.00
66 - *HOEPKER ROAD-CELEBRATION BLVD-545 FT E OF MARKET SQUARE - LUMP SUM	1.00	\$20,765.00	\$20,765.00
67 - HOMEWOOD CIR-N THOMPSON DR-175 FT W OF N THOMPSON DR - LUMP SUM	1.00	\$1,139.00	\$1,139.00
68 - HOOVER DR-ELLENWOOD DR-MENDOTA ST - LUMP SUM	1.00	\$2,226.00	\$2,226.00
69 - INDEPENDENCE LN-DECLARATION LN-ANNIVERSARY LN - LUMP SUM	1.00	\$4,538.00	\$4,538.00
70 - JENNA DR-CLOVE DR-BASIL DR - LUMP SUM	1.00	\$2,485.00	\$2,485.00
71 - JUNIPER AVE-MENDOTA ST-DUNCAN DR - LUMP SUM	1.00	\$3,876.00	\$3,876.00
72 - KATIE LN-TONY DR-GOLDEN LEAF TRL - LUMP SUM	1.00	\$2,798.00	\$2,798.00
73 - KINGSFORD WAY-WAYRIDGE DR-ARTISAN DR - LUMP SUM	1.00	\$2,442.00	\$2,442.00
74 - *KINSMAN BLVD-N STOUGHTON RD (NB)-BARTILLON DR - LUMP SUM	1.00	\$2,039.00	\$2,039.00
75 - *LIEN RD-MENDOTA ST-191 FT EAST TO END - LUMP SUM	1.00	\$3,336.00	\$3,336.00
76 - *LIEN RD-E WASHINGTON AVE-THIERER RD - LUMP SUM	1.00	\$15,814.00	\$15,814.00
77 - *LIEN RD FRONTAGE RD-LIEN RD-412 FT SE OF LIEN RD - LUMP SUM	1.00	\$2,208.00	\$2,208.00
78 - LOOMIS CIR-GLACIER HILL DR-E END - LUMP SUM	1.00	\$1,866.00	\$1,866.00
79 - LOTHEVILLE RD-TOMSCOT TRL-PORTAGE RD - LUMP SUM	1.00	\$4,406.00	\$4,406.00
80 - LUKKEN CT-STUART CT-W END - LUMP SUM	1.00	\$2,157.00	\$2,157.00
81 - LYONS CIR-OLD GATE RD-235 FT S OF OLD GATE RD - LUMP SUM	1.00	\$1,667.00	\$1,667.00
82 - MACARTHUR RD-192 FT E OF E WASHINGTON AVE-E WASHINGTON AVE - LUMP SUM	1.00	\$987.00	\$987.00
83 - MEADOW VALE CT-STUART CT-N END - LUMP SUM	1.00	\$2,053.00	\$2,053.00
84 - MELODY LN-PORTAGE RD-INDEPENDENCE LN - LUMP SUM	1.00	\$7,356.00	\$7,356.00
85 - *MENDOTA ST-SYCAMORE AVE-LIEN RD - LUMP SUM	1.00	\$17,990.00	\$17,990.00
86 - MERRICK CT-GLACIER HILL DR-193 FT E OF GLACIER HILL DR - LUMP SUM	1.00	\$1,409.00	\$1,409.00
87 - MESTA LN-COMMERCIAL AVE-N THOMPSON DR - LUMP SUM	1.00	\$5,928.00	\$5,928.00
88 - MORGAN WAY-NELSON RD-GRAND CROSSING RD - LUMP SUM	1.00	\$1,518.00	\$1,518.00
89 - N BARTELT CT-OLD GATE RD-N END - LUMP SUM	1.00	\$1,799.00	\$1,799.00
90 - *N BILTMORE LN-BUTTONWOOD DR-EASTPARK BLVD - LUMP SUM	1.00	\$15,675.00	\$15,675.00
91 - N STOUGHTON RD SERVICE RD-N STOUGHTON RD (NB)-ORIN RD - LUMP SUM	1.00	\$2,516.00	\$2,516.00
92 - OAK VALLEY DR-N THOMPSON DR-GLACIER HILL DR - LUMP SUM	1.00	\$9,907.00	\$9,907.00
93 - OLD GATE RD-RIEDER RD-PORTAGE RD - LUMP SUM	1.00	\$16,427.00	\$16,427.00
94 - ONSGARD RD-LIEN RD-ORIN RD - LUMP SUM	1.00	\$3,706.00	\$3,706.00
95 - ORIN RD-BARTILLON DR-ONSGARD RD - LUMP SUM	1.00	\$2,927.00	\$2,927.00
96 - PARK MEADOW DR-GLACIER HILL DR-GOLDEN LEAF TRL - LUMP SUM	1.00	\$8,172.00	\$8,172.00
97 - *PARKSIDE DR-S END-PORTAGE RD - LUMP SUM	1.00	\$15,626.00	\$15,626.00
98 - PEPPER WOOD CT-GREEN RIDGE DR-E END - LUMP SUM	1.00	\$1,526.00	\$1,526.00

CHIP SEALING 2018 - EAST

CONTRACT NO. 8093

DATE: 4/12/18

**Fahrner Asphalt Sealers,
L.L.C.**

Item	Quantity	Price	Extension
99 - PRAIRIE ROSE RD-MESTA LN-EAGLE CREST DR - LUMP SUM	1.00	\$6,956.00	\$6,956.00
100 - PROMONTORY PL-S END-HIGH CROSSING BLVD - LUMP SUM	1.00	\$3,594.00	\$3,594.00
101 - QUARRY PARK RD-CITY VIEW DR-489 FT E OF QUARRY PARK RD - LUMP SUM	1.00	\$2,970.00	\$2,970.00
102 - RIDGE OAK DR-BULTMAN RD-GLACIER HILL DR - LUMP SUM	1.00	\$7,326.00	\$7,326.00
103 - S BARTELT CT-OLD GATE RD-S END - LUMP SUM	1.00	\$2,102.00	\$2,102.00
104 - *S BILTMORE LN-EASTPARK BLVD-BUTTONWOOD DR - LUMP SUM	1.00	\$17,876.00	\$17,876.00
105 - SAGE CIR-OLD GATE RD-404 FT SE OF OLD GATE RD - LUMP SUM	1.00	\$2,437.00	\$2,437.00
106 - SOUTHRIDGE DR-ESKER DR-GLACIER HILL DR - LUMP SUM	1.00	\$7,805.00	\$7,805.00
107 - STONE CORNER CIR-SUMMER RIDGE DR-S END - LUMP SUM	1.00	\$1,667.00	\$1,667.00
108 - STUART CT-SUNNYSIDE CRES-MELODY LN - LUMP SUM	1.00	\$5,391.00	\$5,391.00
109 - SUMMER RIDGE DR-OAK VALLEY DR-GLACIER HILL DR - LUMP SUM	1.00	\$7,545.00	\$7,545.00
110 - SUNBROOK RD-TOMSCOT TRL-SURREY CIR - LUMP SUM	1.00	\$3,285.00	\$3,285.00
111 - SUNNYSIDE CRES-DUKE ST-DWIGHT DR - LUMP SUM	1.00	\$4,958.00	\$4,958.00
112 - SUTTERIDGE TRL-WESTERFIELD LN-BELGROVE LN - LUMP SUM	1.00	\$1,233.00	\$1,233.00
113 - *SYCAMORE AVE-MENDOTA ST-918 FT E OF MENDOTA ST - LUMP SUM	1.00	\$6,395.00	\$6,395.00
114 - *TANCHO DR-AMERICAN FAMILY DR-AMERICAN PKWY - LUMP SUM	1.00	\$25,377.00	\$25,377.00
115 - TERRACE CT-WEST TERRACE DR-631 FT W OF WEST TERRACE DR - LUMP SUM	1.00	\$3,915.00	\$3,915.00
116 - THIERER RD-LIEN RD-E WASHINGTON AVE - LUMP SUM	1.00	\$9,842.00	\$9,842.00
117 - TOMSCOT TRL-316 FT N OF OLD GATE RD-SUNBROOK RD - LUMP SUM	1.00	\$10,575.00	\$10,575.00
118 - TONY DR-228 FT S OF HAZELCREST DR-PARK MEADOW DR - LUMP SUM	1.00	\$7,364.00	\$7,364.00
119 - TREE RIDGE TRL-FIELDWOOD RD-CELEBRATION PKWY - LUMP SUM	1.00	\$3,927.00	\$3,927.00
120 - TWIN PINES DR-PRAIRIE ROSE RD-HAZELCREST DR - LUMP SUM	1.00	\$6,673.00	\$6,673.00
121 - VALLEY EDGE DR-GLACIER HILL DR-PARK MEADOW DR - LUMP SUM	1.00	\$3,054.00	\$3,054.00
122 - VERNON RD-CUL DE SAC-855 FT N OF COMMERCIAL AVE - LUMP SUM	1.00	\$1,572.00	\$1,572.00
123 - VERNON RD-306 FT S OF HAZELCREST DR-HAZELCREST DR - LUMP SUM	1.00	\$1,541.00	\$1,541.00
124 - VICTORIA LN-BUNKER HILL LN-N END - LUMP SUM	1.00	\$4,569.00	\$4,569.00
125 - VIDON DR-SUTTERIDGE TRL-143 FT N OF DI LORETO AVE - LUMP SUM	1.00	\$4,087.00	\$4,087.00
126 - VILLAGE PARK DR-AMERICAN PKWY-FIELDWOOD RD - LUMP SUM	1.00	\$4,133.00	\$4,133.00
127 - *WALL ST-CROSSROADS DR-CITY VIEW DR - LUMP SUM	1.00	\$5,610.00	\$5,610.00

CHIP SEALING 2018 - EAST

CONTRACT NO. 8093

DATE: 4/12/18

**Fahrner Asphalt Sealers,
L.L.C.**

Item	Quantity	Price	Extension
128 - WAYNE TER-264 FT SW OF LANCASTER DR-LANCASTER DR - LUMP SUM	1.00	\$2,036.00	\$2,036.00
129 - WAYRIDGE DR-SYCAMORE AVE-N THOMPSON DR - LUMP SUM	1.00	\$12,679.00	\$12,679.00
130 - WAYWOOD CIR-N THOMPSON DR-206 FT E OF N THOMPSON DR - LUMP SUM	1.00	\$1,308.00	\$1,308.00
131 - *WEST TERRACE DR-EASTPARK BLVD-EAST TERRACE DR - LUMP SUM	1.00	\$4,402.00	\$4,402.00
132 - WESTEND CIR-WAYRIDGE DR-493 FT NW OF WAYRIDGE DR - LUMP SUM	1.00	\$3,046.00	\$3,046.00
133 - WESTERFIELD LN-SUTTERIDGE TRL-VIDON DR - LUMP SUM	1.00	\$3,285.00	\$3,285.00
134 - WESTRIDGE CIR-WAYRIDGE DR-113 FT SW OF WAYRIDGE DR - LUMP SUM	1.00	\$891.00	\$891.00
135 - WESTWYNN CIR-N THOMPSON DR-294 FT W OF N THOMPSON DR - LUMP SUM	1.00	\$1,755.00	\$1,755.00
136 - WILTON CT-OLD GATE RD-E END - LUMP SUM	1.00	\$2,166.00	\$2,166.00
137 - WINTERGREEN DR-MESTA LN-PRAIRIE ROSE RD - LUMP SUM	1.00	\$8,435.00	\$8,435.00
138 - WOODRIDGE CT-SYCAMORE AVE-175 FT N OF SYCAMORE AVE - LUMP SUM	1.00	\$1,167.00	\$1,167.00
139 - WYNBROOK CIR-N THOMPSON DR-143 FT E OF N THOMPSON DR - LUMP SUM	1.00	\$924.00	\$924.00
21041 - INLET PROTECTION, TYPE D - COMPLETE(UNDISTRIBUTED) - EACH	10.00	\$5.00	\$50.00
60800 - PAVEMENT MARKING EPOXY, 4-INCH SOLID WHITE - L.F.	500.00	\$0.30	\$150.00
60801 - PAVEMENT MARKING EPOXY, 4-INCH DOUBLE YELLOW - L.F.	10498.00	\$0.60	\$6,298.80
60802 - PAVEMENT MARKING EPOXY, 6-INCH SOLID WHITE - L.F.	27789.00	\$0.44	\$12,227.16
60802 - PAVEMENT MARKING EPOXY, 6-INCH WHITE SKIPS, (2' Line, 6' GAP) - L.F.	162.00	\$0.50	\$81.00
60802 - PAVEMENT MARKING EPOXY, 6-INCH WHITE SKIPS, (10' LINE 30' GAP) - L.F.	4080.00	\$0.50	\$2,040.00
60802 - PAVEMENT MARKING EPOXY, 6-INCH YELLOW SKIPS, (10' LINE 30' GAP) - L.F.	590.00	\$0.50	\$295.00
60803 - PAVEMENT MARKING EPOXY, 8-INCH SOLID WHITE - L.F.	2250.00	\$1.00	\$2,250.00
60803 - PAVEMENT MARKING EPOXY, 8-INCH WHITE SKIPS, (2' Line, 6' GAP) - L.F.	110.00	\$1.00	\$110.00
60803 - PAVEMENT MARKING EPOXY, 8-INCH WHITE SKIPS, (5' Line, 5' GAP) - L.F.	200.00	\$1.00	\$200.00
60806 - PAVEMENT MARKING EPOXY, RADIUS LINE, 6-INCH (5' LINE, 5' GAP) - L.F.	90.00	\$10.00	\$900.00
60810 - PAVEMENT MARKING EPOXY, DIAGONAL LINE, 8-INCH - L.F.	168.00	\$5.40	\$907.20
60812 - PAVEMENT MARKING EPOXY, CROSSWALK, 6-INCH - L.F.	2980.00	\$4.25	\$12,665.00
60815 - PAVEMENT MARKING EPOXY, CROSSWALK, 18-INCH - L.F.	90.00	\$5.80	\$522.00
60818 - PAVEMENT MARKING EPOXY, STOP LINE, 24-INCH - L.F.	747.00	\$6.00	\$4,482.00
60822 - PAVEMENT MARKING EPOXY, SYMBOL, BIKE SHARROW - EACH	4.00	\$160.00	\$640.00

CHIP SEALING 2018 - EAST
 CONTRACT NO. 8093
 DATE: 4/12/18

Fahrner Asphalt Sealers,
 L.L.C.

Item	Quantity	Price	Extension
60823 - PAVEMENT MARKING EPOXY, SYMBOL, BIKE LANE - EACH	10.00	\$140.00	\$1,400.00
60824 - PAVEMENT MARKING EPOXY, SYMBOL, BIKE STRAIGHT ARROW - EACH	13.00	\$190.00	\$2,470.00
60829 - PAVEMENT MARKING EPOXY, SYMBOL, LEFT ARROW - EACH	8.00	\$130.00	\$1,040.00
60830 - PAVEMENT MARKING EPOXY, SYMBOL, RIGHT ARROW - EACH	6.00	\$130.00	\$780.00
60831 - PAVEMENT MARKING EPOXY, SYMBOL, STRAIGHT ARROW - EACH	2.00	\$130.00	\$260.00
60834 - PAVEMENT MARKING EPOXY, WORD, ONLY - EACH	13.00	\$140.00	\$1,820.00
60880 - PAVEMENT MARKING REMOVAL, 4-INCH - L.F.	750.00	\$0.50	\$375.00
60881 - PAVEMENT MARKING REMOVAL, 6-INCH - L.F.	11500.00	\$0.60	\$6,900.00
60882 - PAVEMENT MARKING REMOVAL, 8-INCH - L.F.	2500.00	\$0.65	\$1,625.00
60886 - PAVEMENT MARKING REMOVAL, 4" DOUBLE LINE - L.F.	9500.00	\$0.50	\$4,750.00
140 - CAMDEN RD-MORNINGSIDE AVE-ALLIS AVE - LUMP SUM	1.00	\$13,139.00	\$13,139.00
141 - DAVIES ST-BUCKEYE RD-MAHER AVE - LUMP SUM	1.00	\$9,009.00	\$9,009.00
142 - DEMPSEY RD-PARK CT-MAHER AVE - LUMP SUM	1.00	\$5,457.00	\$5,457.00
143 - DREWRY LN-ESCH LN-HANOVER ST - LUMP SUM	1.00	\$3,703.00	\$3,703.00
144 - ELINOR ST-GARY ST-PINCHOT AVE - LUMP SUM	1.00	\$2,640.00	\$2,640.00
145 - HANOVER ST-LAKE VIEW AVE-MAYFIELD LN - LUMP SUM	1.00	\$3,988.00	\$3,988.00
146 - KENWOOD ST-LONGVIEW ST-MAYFIELD LN - LUMP SUM	1.00	\$1,653.00	\$1,653.00
147 - LONGVIEW ST-KENWOOD ST-HANOVER ST - LUMP SUM	1.00	\$2,904.00	\$2,904.00
148 - MAYFIELD LN-KENWOOD ST-N SHERMAN AVE - LUMP SUM	1.00	\$9,276.00	\$9,276.00
149 - SPAANEM AVE-BUCKEYE RD-PFLAUM RD - LUMP SUM	1.00	\$23,757.00	\$23,757.00
175 Items	Totals		\$1,111,337.16



Department of Public Works
City Engineering Division

Larry D. Nelson, P.E.
City Engineer

City-County Building, Room 115
210 Martin Luther King, Jr. Boulevard
Madison, Wisconsin 53703
608 264 9275 FAX
1 866 704 2315 Textnet

Replaces Biennial Bid Bond in the name of:
Fahrner Asphalt Sealers, LLC
Dated December 4, 2014

608 266 4751

Deputy City Engineer
Robert F. Phillips, P.E.

Principal Engineers
Michael R. Dailey, P.E.
Christina M. Bachmann, P.E.
John S. Fahrney, P.E.
Gregory T. Fries, P.E.

Facilities & Sustainability
Jeanne E. Hoffman, Manager
James C. Whitney, A.I.A.

Operations Supervisor
Kathleen M. Cryan

Hydrogeologist
Joseph L. DeMorett, P.G.

GIS Manager
David A. Davis, R.L.S.

Financial Officer
Steven B. Danner-Rivers

BIENNIAL BID BOND

Fahrner Asphalt Sealers, L.L.C.

(a corporation of the State of Limited Liability Company of the State of WI)
(individual), (partnership), (hereinafter referred to as the "Principal") and
Western Surety Company

a corporation of the State of SD (hereinafter referred to as the "Surety") and licensed to do business in the State of Wisconsin, are held and firmly bound unto the City of Madison, Wisconsin (hereinafter referred to as the "City"), in the sum equal to the individual proposal guaranty amounts of the total bid or bids of the Principal herein accepted by the City, for the payment of which the Principal and the Surety hereby jointly and severally bind ourselves, our heirs, executors, administrators, successors and assigns.

The condition of this obligation is that the Principal has submitted to the City certain bids for projects from the time period of January 1, 2017 through January 31, 2019.

If the Principal is awarded the contract(s) by the City and, within the time and manner required by law after the prescribed forms are presented for its signature, the Principal enters into (a) written contract(s) in accordance with the bid(s), and files with the City its bond(s) guaranteeing faithful performance and payment for all labor and materials, as required by law, or if the City rejects all bids for the work described, then this obligation shall be null and void; otherwise, it shall remain in full force and effect.

In the event the Principal shall fail to execute and deliver the contract(s) or the performance and payment bond(s), all within the time specified or any extension thereof, the Principal and Surety agree jointly and severally to pay to the City within ten (10) calendar days of written demand a total equal to the sum of the individual proposal guaranty amounts of the total bid(s) as liquidated damages.

The Surety, for value received, hereby agrees that the obligations of it and its bond shall be in no way impaired or affected by any extension of time within which the City may accept a bid, and the Surety does hereby waive notice of any such extension.

This bond may be terminated by the Surety upon giving thirty (30) days written notice to the City of its intent to terminate this bond and to be released and discharged therefrom, but such termination shall not operate to relieve or discharge the Surety from any liability already accrued or which shall accrue before the expiration of such thirty (30) day period.

IN WITNESS WHEREOF, the Principal and the Surety have hereunto set their hands and seals, and such of them as are corporations have caused their corporate seals to be hereto affixed and these presents to be signed by their proper officers, on the day and year set forth below.

PRINCIPAL

Fahrner Asphalt Sealers, L.L.C. _____
COMPANY NAME AFFIX SEAL DATE January 11, 2017

By:  Vice President
SIGNATURE AND TITLE

SURETY

Western Surety Company _____
COMPANY NAME AFFIX SEAL DATE January 11, 2017

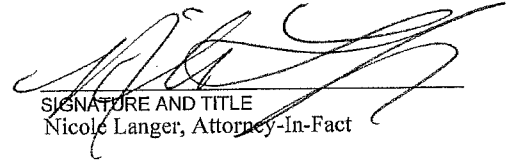
By: 
SIGNATURE AND TITLE
Nicole Langer, Attorney-In-Fact

This certifies that I have been duly licensed as an agent for the Surety in Wisconsin under License No. 2538830 for the year 2017-2019, and appointed as attorney in fact with authority to execute this bid bond, which power of attorney has not been revoked.

January 11, 2017
DATE

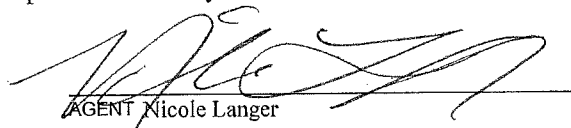
AGENT Nicole Langer

Willis of Minnesota, Inc.
1600 Utica Avenue South, Suite 600
ADDRESS

Minneapolis, MN 55416
CITY, STATE AND ZIP CODE

763-302-7100
TELEPHONE NUMBER

Note to Surety and Principal: Any bid submitted which this bond guarantees may be rejected if the Power of Attorney form showing that the Agent of Surety is currently authorized to execute bonds on behalf of Surety is not attached to this bond.

CERTIFICATE OF BIENNIAL BID BOND

TIME PERIOD - VALID (FROM/TO) January 1, 2017 to January 31, 2019
NAME OF SURETY Western Surety Company
NAME OF CONTRACTOR Fahrner Asphalt Sealers, L.L.C.
CERTIFICATE HOLDER City of Madison, Wisconsin

This is to certify that a biennial bid bond issued by the above-named Surety is currently on file with the City of Madison.

This certificate is issued as a matter of information and conveys no rights upon the certificate holder and does not amend, extend or alter the coverage of the biennial bid bond.

Cancellation: Should the above policy be cancelled before the expiration date, the issuing Surety will give thirty (30) days written notice to the certificate holder indicated above.



SIGNATURE OF AUTHORIZED CONTRACTOR REPRESENTATIVE

1-11-2017

DATE

Surety Acknowledgment

State of Minnesota }
 } ss.
County of Hennepin }

On this 11th day of January 2017, before me personally came Nicole Langer, to me known, who being by me duly sworn, did depose and say that she is the Attorney-in-Fact of Western Surety Company described in and which executed the above instrument; that she/he knows the seal of said corporation; that the seal affixed to said instruments is such corporate seal, that it was so affixed by order of the Board of Directors of said corporation, and that she/he signed her/she/his name to it by like order.

Heather R Goedel

Notary Public

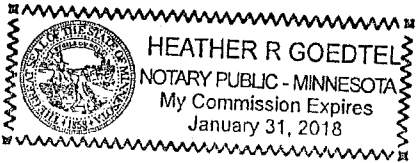

Western Surety Company

POWER OF ATTORNEY APPOINTING INDIVIDUAL ATTORNEY-IN-FACT

Know All Men By These Presents, That WESTERN SURETY COMPANY, a South Dakota corporation, is a duly organized and existing corporation having its principal office in the City of Sioux Falls, and State of South Dakota, and that it does by virtue of the signature and seal herein affixed hereby make, constitute and appoint

Nina E Werstein, Laurie Pflug, Brian D Carpenter, Jill N Swanson, Dennis G Loots, Jessica Hoff, Michelle Sylvester, Heather R Goedtel, Nicole Langer, Craig Olmstead, Individually

of Minneapolis, MN, its true and lawful Attorney(s)-in-Fact with full power and authority hereby conferred to sign, seal and execute for and on its behalf bonds, undertakings and other obligatory instruments of similar nature

- In Unlimited Amounts -

and to bind it thereby as fully and to the same extent as if such instruments were signed by a duly authorized officer of the corporation and all the acts of said Attorney, pursuant to the authority hereby given, are hereby ratified and confirmed.

This Power of Attorney is made and executed pursuant to and by authority of the By-Law printed on the reverse hereof, duly adopted, as indicated, by the shareholders of the corporation.

In Witness Whereof, WESTERN SURETY COMPANY has caused these presents to be signed by its Vice President and its corporate seal to be hereto affixed on this 2nd day of July, 2015.



WESTERN SURETY COMPANY

Paul T. Bruflat

Paul T. Bruflat, Vice President

State of South Dakota }
County of Minnehaha } ss

On this 2nd day of July, 2015, before me personally came Paul T. Bruflat, to me known, who, being by me duly sworn, did depose and say: that he resides in the City of Sioux Falls, State of South Dakota; that he is the Vice President of WESTERN SURETY COMPANY described in and which executed the above instrument; that he knows the seal of said corporation; that the seal affixed to the said instrument is such corporate seal; that it was so affixed pursuant to authority given by the Board of Directors of said corporation and that he signed his name thereto pursuant to like authority, and acknowledges same to be the act and deed of said corporation.

My commission expires

February 12, 2021

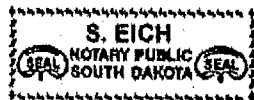

S. Eich

S. Eich, Notary Public

CERTIFICATE

I, L. Nelson, Assistant Secretary of WESTERN SURETY COMPANY do hereby certify that the Power of Attorney hereinabove set forth is still in force, and further certify that the By-Law of the corporation printed on the reverse hereof is still in force. In testimony whereof I have hereunto subscribed my name and affixed the seal of the said corporation this 11th day of January, 2017.



WESTERN SURETY COMPANY

L. Nelson

L. Nelson, Assistant Secretary

SECTION H: AGREEMENT

THIS AGREEMENT made this 2d day of MAY in the year Two Thousand and Eighteen between **FAHRNER ASPHALT SEALERS, L.L.C.** hereinafter called the Contractor, and the City of Madison, Wisconsin, hereinafter called the City.

WHEREAS, the Common Council of the said City of Madison under the provisions of a resolution adopted **MAY 1, 2018**, and by virtue of authority vested in the said Council, has awarded to the Contractor the work of performing certain construction.

NOW, THEREFORE, the Contractor and the City, for the consideration hereinafter named, agree as follows:

1. **Scope of Work.** The Contractor shall, perform the construction, execution and completion of the following listed complete work or improvement in full compliance with the Plans, Specifications, Standard Specifications, Supplemental Specifications, Special Provisions and contract; perform all items of work covered or stipulated in the proposal; perform all altered or extra work; and shall furnish, unless otherwise provided in the contract, all materials, implements, machinery, equipment, tools, supplies, transportation, and labor necessary to the prosecution and completion of the work or improvements:

CHIP SEALING 2018 - EAST CONTRACT NO. 8093

2. **Completion Date/Contract Time.** Construction work must begin within seven (7) calendar days after the date appearing on mailed written notice to do so shall have been sent to the Contractor and shall be carried on at a rate so as to secure full completion SEE SPECIAL PROVISIONS, the rate of progress and the time of completion being essential conditions of this Agreement.
3. **Contract Price.** The City shall pay to the Contractor at the times, in the manner and on the conditions set forth in said specifications, the sum of **ONE MILLION ONE HUNDRED ELEVEN THOUSAND THREE HUNDRED THIRTY-SEVEN AND 16/100 (\$1,111,337.16)** Dollars being the amount bid by such Contractor and which was awarded to him/her as provided by law.
4. **Affirmative Action.** In the performance of the services under this Agreement the Contractor agrees not to discriminate against any employee or applicant because of race, religion, marital status, age, color, sex, disability, national origin or ancestry, income level or source of income, arrest record or conviction record, less than honorable discharge, physical appearance, sexual orientation, gender identity, political beliefs, or student status. The Contractor further agrees not to discriminate against any subcontractor or person who offers to subcontract on this contract because of race, religion, color, age, disability, sex, sexual orientation, gender identity or national origin.

The Contractor agrees that within thirty (30) days after the effective date of this agreement, the Contractor will provide to the City Affirmative Action Division certain workforce utilization statistics, using a form to be furnished by the City.

If the contract is still in effect, or if the City enters into a new agreement with the Contractor, within one year after the date on which the form was required to be provided, the Contractor will provide updated workforce information using a second form, also to be furnished by the City. The second form will be submitted to the City Affirmative Action Division no later than one year after the date on which the first form was required to be provided.

The Contractor further agrees that, for at least twelve (12) months after the effective date of this contract, it will notify the City Affirmative Action Division of each of its job openings at facilities in Dane County for which applicants not already employees of the Contractor are to be considered. The notice will include a job description, classification, qualifications and application procedures

and deadlines. The Contractor agrees to interview and consider candidates referred by the Affirmative Action Division if the candidate meets the minimum qualification standards established by the Contractor, and if the referral is timely. A referral is timely if it is received by the Contractor on or before the date started in the notice.

Articles of Agreement

Article I

The Contractor shall take affirmative action in accordance with the provisions of this contract to insure that applicants are employed, and that employees are treated during employment without regard to race, religion, color, age, marital status, disability, sex, sexual orientation, gender identity or national origin and that the employer shall provide harassment free work environment for the realization of the potential of each employee. Such action shall include, but not be limited to, the following: employment, upgrading, demotion or transfer, recruitment or recruitment advertising, layoff or termination, rates of pay or other forms of compensation and selection for training including apprenticeship insofar as it is within the control of the Contractor. The Contractor agrees to post in conspicuous places available to employees and applicants notices to be provided by the City setting out the provisions of the nondiscrimination clauses in this contract.

Article II

The Contractor shall in all solicitations or advertisements for employees placed by or on behalf of the Contractors state that all qualified or qualifiable applicants will be employed without regard to race, religion, color, age, marital status, disability, sex, sexual orientation, gender identity or national origin.

Article III

The Contractor shall send to each labor union or representative of workers with which it has a collective bargaining agreement or other contract or understanding a notice to be provided by the City advising the labor union or worker's representative of the Contractor's equal employment opportunity and affirmative action commitments. Such notices shall be posted in conspicuous places available to employees and applicants for employment.

Article V

The Contractor agrees that it will comply with all provisions of the Affirmative Action Ordinance of the City of Madison, including the contract compliance requirements. The Contractor agrees to submit the model affirmative action plan for public works contractors in a form approved by the Affirmative Action Division Manager.

Article VI

The Contractor will maintain records as required by Section 39.02(9)(f) of the Madison General Ordinances and will provide the City Affirmative Action Division with access to such records and to persons who have relevant and necessary information, as provided in Section 39.02(9)(f). The City agrees to keep all such records confidential, except to the extent that public inspection is required by law.

Article VII

In the event of the Contractor's or subcontractor's failure to comply with the Equal Employment Opportunity and Affirmative Action Provisions of this contract or Section 39.03 and 39.02 of the Madison General Ordinances, it is agreed that the City at its option may do any or all of the following:

1. Cancel, terminate or suspend this Contract in whole or in part.

2. Declare the Contractor ineligible for further City contracts until the Affirmative Action requirements are met.
3. Recover on behalf of the City from the prime Contractor 0.5 percent of the contract award price for each week that such party fails or refuses to comply, in the nature of liquidated damages, but not to exceed a total of five percent (5%) of the contract price, or five thousand dollars (\$5,000), whichever is less. Under public works contracts, if a subcontractor is in noncompliance, the City may recover liquidated damages from the prime Contractor in the manner described above. The preceding sentence shall not be construed to prohibit a prime Contractor from recovering the amount of such damage from the non-complying subcontractor.

Article VIII

The Contractor shall include the above provisions of this contract in every subcontract so that such provisions will be binding upon each subcontractor. The Contractor shall take such action with respect to any subcontractor as necessary to enforce such provisions, including sanctions provided for noncompliance.

Article IX

The Contractor shall allow the maximum feasible opportunity to small business enterprises to compete for any subcontracts entered into pursuant to this contract. (In federally funded contracts the terms "DBE, MBE and WBE" shall be substituted for the term "small business" in this Article.)

5. Substance Abuse Prevention Program Required. Prior to commencing work on the Contract, the Contractor, and any Subcontractor, shall have in place a written program for the prevention of substance abuse among its employees as required under Wis. Stat. Sec. 103.503.
6. **Contractor Hiring Practices.**

Ban the Box - Arrest and Criminal Background Checks. (Sec. 39.08, MGO)

This provision applies to all prime contractors on contracts entered into on or after January 1, 2016, and all subcontractors who are required to meet prequalification requirements under MGO 33.07(7)(I), MGO as of the first time they seek or renew pre-qualification status on or after January 1, 2016. The City will monitor compliance of subcontractors through the pre-qualification process.

- a. **Definitions.** For purposes of this section, "Arrest and Conviction Record" includes, but is not limited to, information indicating that a person has been questioned, apprehended, taken into custody or detention, held for investigation, arrested, charged with, indicted or tried for any felony, misdemeanor or other offense pursuant to any law enforcement or military authority.

"Conviction record" includes, but is not limited to, information indicating that a person has been convicted of a felony, misdemeanor or other offense, placed on probation, fined, imprisoned or paroled pursuant to any law enforcement or military authority.

"Background Check" means the process of checking an applicant's arrest and conviction record, through any means.

- b. **Requirements.** For the duration of this Contract, the Contractor shall:
 1. Remove from all job application forms any questions, check boxes, or other inquiries regarding an applicant's arrest and conviction record, as defined herein.

2. Refrain from asking an applicant in any manner about their arrest or conviction record until after conditional offer of employment is made to the applicant in question.
3. Refrain from conducting a formal or informal background check or making any other inquiry using any privately or publicly available means of obtaining the arrest or conviction record of an applicant until after a conditional offer of employment is made to the applicant in question.
4. Make information about this ordinance available to applicants and existing employees, and post notices in prominent locations at the workplace with information about the ordinance and complaint procedure using language provided by the City.
5. Comply with all other provisions of Sec. 39.08, MGO.

c. Exemptions: This section shall not apply when:

1. Hiring for a position where certain convictions or violations are a bar to employment in that position under applicable law, or
2. Hiring a position for which information about criminal or arrest record, or a background check is required by law to be performed at a time or in a manner that would otherwise be prohibited by this ordinance, including a licensed trade or profession where the licensing authority explicitly authorizes or requires the inquiry in question.

To be exempt, Contractor has the burden of demonstrating that there is an applicable law or regulation that requires the hiring practice in question, if so, the contractor is exempt from all of the requirements of this ordinance for the position(s) in question.

**CHIP SEALING 2018 - EAST
CONTRACT NO. 8093**

IN WITNESS WHEREOF, the Contractor has hereunto set his/her hand and seal and the City has caused these presents to be sealed with its corporate seal and to be subscribed by its Mayor and City Clerk the day and year first above written.

Countersigned:

FAHRNER ASPHALT SEALERS, L.L.C.

[Signature] 5/2/18
 Witness Date

[Signature] 5/2/18
 Witness Date

[Signature] 5/2/18
 Company Name President Date

[Signature] 5/2/18
 Secretary Date

CITY OF MADISON, WISCONSIN

Provisions have been made to pay the liability that will accrue under this contract.

Approved as to form:

[Signature]
 Finance Director

Signed this 18th day of May

[Signature]
 Witness

[Signature]
 Witness

[Signature]
 City Attorney

[Signature] 20 18
 Mayor Date

[Signature] 18 May 2018
 Mayor Date

[Signature] 5-8-2018
 City Clerk Date

SECTION I: PAYMENT AND PERFORMANCE BOND

KNOW ALL MEN BY THESE PRESENTS, that we FAHRNER ASPHALT SEALERS, L.L.C. as principal, and Western Surety Company Company of 333 S. Wabash Ave., Chicago, IL 60604 as surety, are held and firmly bound unto the City of Madison, Wisconsin, in the sum of ONE MILLION ONE HUNDRED ELEVEN THOUSAND THREE HUNDRED THIRTY-SEVEN AND 16/100 (\$1,111,337.16) Dollars, lawful money of the United States, for the payment of which sum to the City of Madison, we hereby bind ourselves and our respective executors and administrators firmly by these presents.

The condition of this Bond is such that if the above bounden shall on his/her part fully and faithfully perform all of the terms of the Contract entered into between him/herself and the City of Madison for the construction of:

**CHIP SEALING 2018 - EAST
CONTRACT NO. 8093**

in Madison, Wisconsin, and shall pay all claims for labor performed and material furnished in the prosecution of said work, and save the City harmless from all claims for damages because of negligence in the prosecution of said work, and shall save harmless the said City from all claims for compensation (under Chapter 102, Wisconsin Statutes) of employees and employees of subcontractor, then this Bond is to be void, otherwise of full force, virtue and effect.

Signed and sealed this 2nd day of May, 2018

Countersigned:

[Signature]
Witness
[Signature]
Secretary

FAHRNER ASPHALT SEALERS, L.L.C.
Company Name (Principal) **"NO CORPORATE SEAL ADOPTED"**
[Signature]
President Seal

Approved as to form:

[Signature]
City Attorney

Western Surety Company
Surety Seal
 Salary Employee Commission
By [Signature]
Attorney-in-Fact Nicole Langer

This certifies that I have been duly licensed as an agent for the above company in Wisconsin under National Producer Number 2538830 for the year 2018, and appointed as attorney-in-fact with authority to execute this payment and performance bond which power of attorney has not been revoked.

May 2, 2018
Date

[Signature]
Agent Signature Nicole Langer

Surety Acknowledgment

State of Minnesota }
County of Hennepin } ss.

On this 2nd day of May 2018, before me personally came Nicole Langer, to me known, who being by me duly sworn, did depose and say that she is the Attorney-in-Fact of Western Surety Company described in and which executed the above instrument; that she/he knows the seal of said corporation; that the seal affixed to said instruments is such corporate seal, that it was so affixed by order of the Board of Directors of said corporation, and that she/he signed her/she/his name to it by like order.

Notary Public

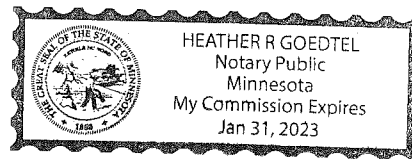

Western Surety Company

POWER OF ATTORNEY APPOINTING INDIVIDUAL ATTORNEY-IN-FACT

Know All Men By These Presents, That WESTERN SURETY COMPANY, a South Dakota corporation, is a duly organized and existing corporation having its principal office in the City of Sioux Falls, and State of South Dakota, and that it does by virtue of the signature and seal herein affixed hereby make, constitute and appoint

Laurie Pflug, Jill N. Swanson, Brian D. Carpenter, Jessica Hoff, Heather R. Goedtel, Nicole Langer, Craig Olmstead, Kelly Bruggeman, Michelle Halter, Individually

of Minneapolis, MN, its true and lawful Attorney(s)-in-Fact with full power and authority hereby conferred to sign, seal and execute for and on its behalf bonds, undertakings and other obligatory instruments of similar nature

- In Unlimited Amounts -

and to bind it thereby as fully and to the same extent as if such instruments were signed by a duly authorized officer of the corporation and all the acts of said Attorney, pursuant to the authority hereby given, are hereby ratified and confirmed.

This Power of Attorney is made and executed pursuant to and by authority of the By-Law printed on the reverse hereof, duly adopted, as indicated, by the shareholders of the corporation.

In Witness Whereof, WESTERN SURETY COMPANY has caused these presents to be signed by its Vice President and its corporate seal to be hereto affixed on this 21st day of February, 2018.

WESTERN SURETY COMPANY



Paul T. Bruflat
Paul T. Bruflat, Vice President

State of South Dakota }
County of Minnehaha } ss

On this 21st day of February, 2018, before me personally came Paul T. Bruflat, to me known, who, being by me duly sworn, did depose and say: that he resides in the City of Sioux Falls, State of South Dakota; that he is the Vice President of WESTERN SURETY COMPANY described in and which executed the above instrument; that he knows the seal of said corporation; that the seal affixed to the said instrument is such corporate seal; that it was so affixed pursuant to authority given by the Board of Directors of said corporation and that he signed his name thereto pursuant to like authority, and acknowledges same to be the act and deed of said corporation.

My commission expires

June 23, 2021

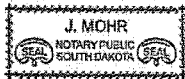

J. Mohr
J. Mohr, Notary Public

CERTIFICATE

I, L. Nelson, Assistant Secretary of WESTERN SURETY COMPANY do hereby certify that the Power of Attorney hereinabove set forth is still in force, and further certify that the By-Law of the corporation printed on the reverse hereof is still in force. In testimony whereof I have hereunto subscribed my name and affixed the seal of the said corporation this 2nd day of May, 2018.



WESTERN SURETY COMPANY

L. Nelson
L. Nelson, Assistant Secretary

Form F4280-7-2012

Go to www.cnasurety.com > Owner / Oblige Services > Validate Bond Coverage, if you want to verify bond authenticity.

Authorizing By-Law

ADOPTED BY THE SHAREHOLDERS OF WESTERN SURETY COMPANY

This Power of Attorney is made and executed pursuant to and by authority of the following By-Law duly adopted by the shareholders of the Company.

Section 7. All bonds, policies, undertakings, Powers of Attorney, or other obligations of the corporation shall be executed in the corporate name of the Company by the President, Secretary, and Assistant Secretary, Treasurer, or any Vice President, or by such other officers as the Board of Directors may authorize. The President, any Vice President, Secretary, any Assistant Secretary, or the Treasurer may appoint Attorneys in Fact or agents who shall have authority to issue bonds, policies, or undertakings in the name of the Company. The corporate seal is not necessary for the validity of any bonds, policies, undertakings, Powers of Attorney or other obligations of the corporation. The signature of any such officer and the corporate seal may be printed by facsimile.